

WHO/IVB/04.10  
ORIGINAL: ENGLISH



# Polio laboratory manual

4th edition, 2004



World Health Organization, Geneva, Switzerland

Fourth edition, final revision, 31 August 2004

---

The Department of Immunization, Vaccines and Biologicals  
thanks the donors whose unspecified financial support  
has made the production of this document possible.

Ordering code: WHO/IVB/04.10  
Printed: September 2004

Copies may be requested from:  
World Health Organization  
Department of Immunization, Vaccines and Biologicals  
CH-1211 Geneva 27, Switzerland  
Fax: +41 22 791 4227; Email: [vaccines@who.int](mailto:vaccines@who.int)

This document revises and replaces the  
*Manual for the virological investigation of polio*  
WHO/EPI/GEN/97.01.

© World Health Organization 2004

All rights reserved. Publications of the World Health Organization can be obtained from Marketing and Dissemination, World Health Organization, 20 Avenue Appia, 1211 Geneva 27, Switzerland (tel: +41 22 791 2476; fax: +41 22 791 4857; email: [bookorders@who.int](mailto:bookorders@who.int)). Requests for permission to reproduce or translate WHO publications – whether for sale or for noncommercial distribution – should be addressed to Publications, at the above address (fax: +41 22 791 4806; email: [permissions@who.int](mailto:permissions@who.int)).

The designations employed and the presentation of the material in this publication do not imply the expression of any opinion whatsoever on the part of the World Health Organization concerning the legal status of any country, territory, city or area or of its authorities, or concerning the delimitation of its frontiers or boundaries. Dotted lines on maps represent approximate border lines for which there may not yet be full agreement.

The mention of specific companies or of certain manufacturers' products does not imply that they are endorsed or recommended by the World Health Organization in preference to others of a similar nature that are not mentioned. Errors and omissions excepted, the names of proprietary products are distinguished by initial capital letters.

The World Health Organization does not warrant that the information contained in this publication is complete and correct and shall not be liable for any damages incurred as a result of its use.

Printed by the WHO Document Production Services, Geneva, Switzerland

---

# Contents

<i>List of figures</i> .....	<i>v</i>
<i>List of tables</i> .....	<i>vii</i>
<i>Abbreviations and acronyms</i> .....	<i>ix</i>
<b>1. Introduction</b> .....	<b>1</b>
1.1 The Polio Eradication Initiative .....	1
1.2 History of poliomyelitis and polio vaccines.....	4
1.3 Characterization of the pathogen.....	4
1.4 Transmission of poliovirus .....	6
<b>2. Role and function of the laboratory in polio eradication</b> .....	<b>10</b>
2.1 Appropriate investigations.....	10
2.2 Structure and activities of the WHO polio laboratory network .....	11
2.3 Coordination of the network .....	13
2.4 Accreditation of network laboratories.....	15
<b>3. Laboratory quality assurance</b> .....	<b>22</b>
3.1 The basis of laboratory quality assurance.....	22
3.2 Standard operating procedures (SOPs).....	24
3.3 Documentation .....	29
3.4 Equipment and instruments.....	29
3.5 Supplies.....	30
3.6 Laboratory safety.....	34
3.7 Audits .....	37
<b>4. Cell culture techniques</b> .....	<b>39</b>
4.1 Working in the cell culture laboratory .....	39
4.2 Cell culture procedures .....	47
4.3 Composition of media and other reagents used in cell and virus culture .....	59
4.4 Cell culture problems: identification and elimination .....	62
4.5 Hoechst 33258 direct DNA stain for Mycoplasma .....	65
4.6 MYCO-TEST immuno assay for Mycoplasma detection.....	66
4.7 PCR assay for Mycoplasma detection .....	68

---

<b>5.</b>	<b>Evaluating cell line sensitivity .....</b>	<b>73</b>
5.1	Selection of reference standard for quality control of cell lines.....	73
5.2	Preparation of laboratory quality-control standards.....	74
5.3	Titration of laboratory quality control standard .....	75
5.4	Calculation of the virus titre by the Kärber formula .....	78
5.5	Interpreting data on cell-line sensitivity and troubleshooting.....	78
5.6	Procurement of reference poliovirus strains.....	79
<b>6.</b>	<b>Specimen receipt and processing .....</b>	<b>81</b>
6.1	Receipt of specimens .....	81
6.2	Specimen preparation .....	82
6.3	Composition of reagents used in specimen processing .....	85
<b>7.</b>	<b>Isolation and identification of polioviruses .....</b>	<b>87</b>
7.1	Recommended cell lines for the isolation of polioviruses.....	87
7.2	Isolation of polio and other enteroviruses.....	88
7.3	Identification of poliovirus isolates.....	91
7.4	Identification of non-poliovirus enteroviruses .....	98
<b>8.</b>	<b>Intratypic differentiation of polio viruses .....</b>	<b>101</b>
8.1	ELISA method for intratypic differentiation.....	101
8.2	Probe Hybridization method for intratypic differentiation .....	108
8.3	PCR method for intratypic differentiation .....	112
8.4	Protocol for use of two methods of intratypic differentiation of polioviruses .....	119
<b>9.</b>	<b>Investigating wild poliovirus contamination of cell cultures .....</b>	<b>121</b>
9.1	When to suspect wild poliovirus contamination .....	121
9.2	Investigating potential sources of wild poliovirus contaminants .....	122
9.3	Determine if there are lapses in good laboratory practices .....	123
9.4	Determine if samples can be tracked.....	124
9.5	Communicate with the programme during the investigation.....	125
<b>10.</b>	<b>Specimen and isolate transport .....</b>	<b>126</b>
10.1	Transport planning .....	126
10.2	Packaging the materials for transport .....	127
10.3	Genetically modified micro-organisms and organisms .....	139
10.4	Preparing the documentation and sending the package .....	139
<b>11.</b>	<b>Data management.....</b>	<b>142</b>
11.1	Recording receipt of specimens.....	144
11.2	Recording laboratory results .....	147
11.3	Reporting laboratory activity and results.....	150
11.4	Laboratory data for certification.....	151
	<b>Bibliography .....</b>	<b>153</b>

---

# List of figures

Figure 1.1	Progress in polio eradication 1988-2002.....	2
Figure 1.2	Poliovirus genome.....	7
Figure 2.1	Structure of the Global Polio Laboratory Network .....	11
Figure 2.2	Flow-chart of specimen collection and transport .....	14
Figure 3.1	Layout – standard operating procedure .....	26
Figure 3.2	Example – standard operating procedure.....	27
Figure 3.3	Example– standard operating procedure flow-chart .....	28
Figure 3.4	Good microbiological techniques .....	36
Figure 3.5	The Basic Biosafety Level 2 (BSL-2) facility .....	37
Figure 4.1	The Class II, biological safety cabinet .....	43
Figure 4.2	Cell counting using a haemocytometer (based on Freshney).....	53
Figure 4.3	Apparatus for controlled cooling of cells (after Freshney).....	56
Figure 4.4	Liquid and gaseous nitrogen storage containers (after Freshney).....	57
Figure 4.5	Establishment of a cell bank .....	58
Figure 5.1	Preparation of virus dilution of Sabin poliovirus reference strain ....	77
Figure 5.2	Plate layout for titration of laboratory quality control standard .....	77
Figure 5.3	Example of results of titration of Sabin poliovirus reference standard	78
Figure 7.1	Flow-chart for poliovirus isolation in RD and L20B cells.....	90
Figure 7.2	Plate set-up for poliovirus identification test.....	94
Figure 7.3	Titration of virus isolates .....	94
Figure 7.4	Identification of poliovirus isolates using the microtechnique.....	96
Figure 7.5	Identification of enterovirus isolates using the microtechnique.....	100
Figure 8.1	Plate set-up for ELISA poliovirus intratypic differentiation test....	104
Figure 8.2	Example probe hybridization blot.....	112
Figure 8.3	Gel loading template .....	116
Figure 8.4	Electrophoretic mobility of positive control amplification products .....	117

---

Figure 10.1	Triple packaging system.....	129
Figure 10.2	Packing viral isolates in cryovials.....	131
Figure 10.3	Packaging specification marking .....	131
Figure 10.4	Outer packaging and labels for shipment of infectious substances .....	133
Figure 10.5A	Shipper’s declaration for dangerous goods .....	134
Figure 10.5B	Shipper’s declaration for standard shipment of infectious substances, with dry ice .....	135
Figure 10.6	Preparing specimens for shipment .....	136
Figure 10.7	Preparing multiple specimens for shipment .....	137
Figure 10.8	Outer packaging and labels for shipment of diagnostic specimens .....	138
Figure 10.9	Example of customs declaration.....	141
Figure 11.1	Polio laboratory data flow: laboratory results and performance monitoring data flow .....	145
Figure 11.2	Polio laboratory data flow: laboratory data feedback .....	146

---

# List of tables

Table 3.1	Basic laboratory equipment.....	31
Table 3.2	Supplies and reagents for testing 100 specimens for poliovirus isolation.....	33
Table 4.1	Essential items for cell culture.....	41
Table 4.2	Approximate volumes for seeding levels for L20B and RD cell culture.....	51
Table 4.3	Summary of methods for detection of Mycoplasma .....	64
Table 7.1	Preparation of RIVM typing agents.....	92
Table 7.2	Interpretation of virus neutralization patterns in the poliovirus identification test .....	97
Table 8.1	PCR interpretation table.....	117
Table 8.2	PCR primers table .....	118
Table 8.3	Protocol for use of ELISA test and nucleic acid probe hybridization/PCR inn intratypic differentiation .....	119

---

# Abbreviations and acronyms

µg	microgram
µl	microlitre
AFP	acute flaccid paralysis
ART	aerosol resistant tip (for pipettors)
BCIP	5-bromo-4-chloro-3-indoyl-phosphate
BSC	biological safety cabinet
BSL	biological safety level
CCID	cell culture infective dose
CO <sub>2</sub>	carbon dioxide
CDNA	complementary DNA
CPE	cytopathic effect
DNA	deoxyribonucleic acid
DMF	dimethyl formamide
DMSO	dimethyl sulfoxide
DTT	dithiothreitol
EIPV	enhanced inactivated polio vaccine
ELISA	enzyme-linked immunosorbent assay
EPI	Expanded Programme on Immunization
EPID number	unique number assigned to AFP case
FITC	fluorescein isothiocyanate
G	relative centrifugal force
g	gram
GAP	Global Action Plan on containment of wild polioviruses
GM	growth medium
GSL	global specialized laboratory
HEPA	high efficiency particulate filter
IATA	International Air Transport Association
IPV	inactivated polio vaccine (Salk)
ITD	intratypic differentiation
IU	international units
IVB	Department of Immunization, Vaccines and Biologicals
kPa	kilopascal
L	litre
L20B	mouse cell line expressing the gene for the human cellular receptor for poliovirus
LQA	laboratory quality assurance



---

MCB	master cell bank
MEM	minimal essential medium
mg	milligram
min	minute
ml	millilitre
MM	maintenance medium
MW	molecular weight
NBT	4-nitroblue tetrazolium
NIDs	national immunization days
NL	national laboratory
nm	nanometer
NPEV	non-polio enterovirus
NSL	non Sabin-like
OD	optical density
OPV	oral polio vaccine (Sabin)
PBS	phosphate buffered saline
PCR	polymerase chain reaction
PSI	pounds per square inch
PT	proficiency test
PVR	poliovirus receptor
QC	quality control
RD	cell line derived from human rhabdomyosarcoma
RFLP	restriction fragment length polymorphism
RNA	ribonucleic acid
RPM	revolutions per minute
RRL	Regional Reference Laboratory
RT	reverse transcription
SDS	sodium dodecyl sulfate
SL	Sabin-like
SOP	standard operating procedure
SSC	sodium chloride and sodium citrate
TMB	tetramethylbenzidine
U	unit
UP	urea peroxide
VAPP	vaccine-associated paralytic poliomyelitis
V&B	Department of Vaccines and Biologicals ( <i>now named IVB, see above</i> )
VDPV	vaccine derived polio virus
VP	viral protein
WCB	working cell bank
WHA	World Health Assembly
WHO	World Health Organization

---

# 1. Introduction

## 1.1 The Polio Eradication Initiative

In May 1988, the 41st World Health Assembly committed the Member States of the World Health Organization (WHO) to the global eradication of poliomyelitis by the year 2000 (resolution WHA41.28). The resolution specified that the polio eradication initiative should be pursued in ways that would strengthen the Expanded Programme on Immunization (EPI). In 1989, the 42nd World Health Assembly approved a general Plan of Action for Global Polio Eradication.

The global effort to eradicate polio is the largest public health initiative in history. Since the initiative was launched in 1988 extraordinary progress has been made to halt transmission of wild poliovirus and achieve global certification of eradication by 2005. In 1988, polio existed in over 125 countries on five continents, and more than 350 000 children were paralyzed that year. By the end of 2002, the number of polio-infected countries has decreased to seven (*Figure 1.1*), polio has been eliminated from three continents, and reported poliomyelitis cases has fallen to around 1900. Poliomyelitis transmission has been interrupted in the American, European, and Western Pacific Regions, and by end 2002 more than 180 countries and territories were polio-free. With the eradication of polio and the eventual cessation of polio immunization, the world will save US\$ 1.5 billion per year.

Current eradication strategies recommended by WHO have proved successful; these four strategies are:

- high, routine infant immunization coverage with at least three doses of oral polio vaccine (OPV) plus a dose at birth in polio-endemic countries;
- national immunization days (NIDs) targeting all children <5 years;
- acute flaccid paralysis (AFP) surveillance and laboratory investigations; and
- mop-up immunization campaigns to interrupt final chains of transmission.

The laboratory has a crucial role in ensuring that the initiative meets its objectives. Since agents other than polioviruses can cause acute flaccid paralysis, all suspect cases must undergo thorough virological investigation. Most poliovirus infections are asymptomatic, with clinical symptoms being observed in only 0.1 to 1% of infections. For this reason it is essential that stool specimens from every identified AFP case be subjected to thorough and systematic examination for the presence of wild poliovirus — missing virus in one case may mean that a thousand infections have been missed.

**Figure 1.1: Progress in polio eradication 1988–2002**

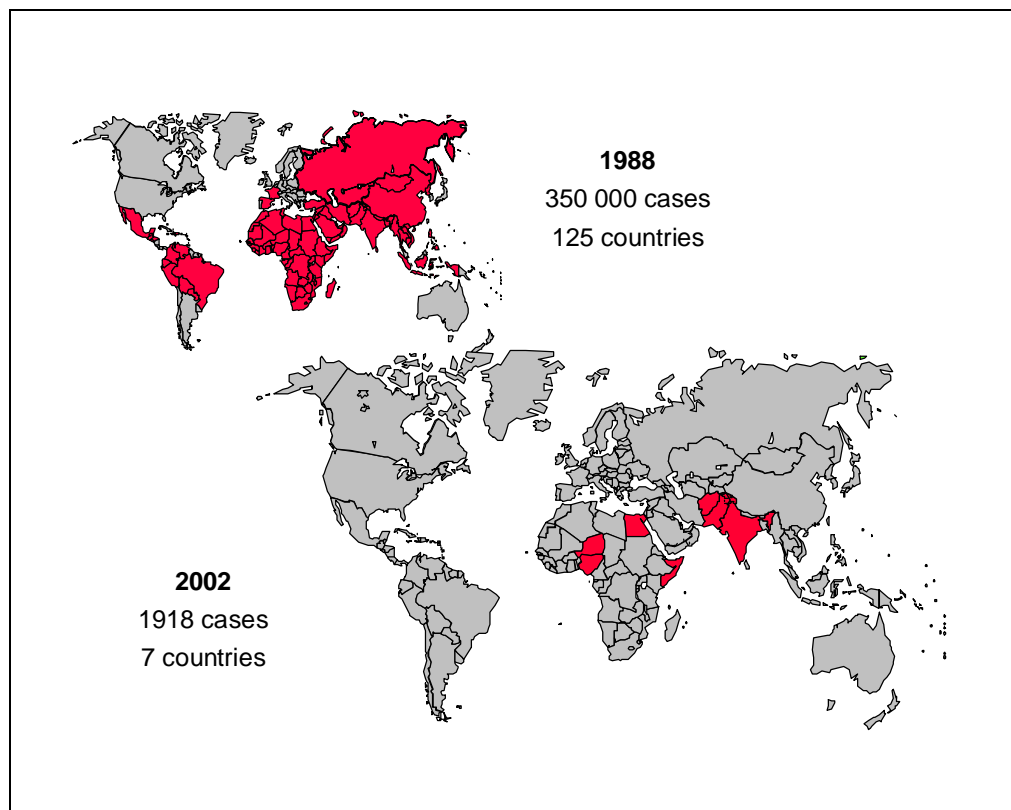

For the eradication initiative to be effective it is essential to achieve close integration between surveillance and laboratory activities to ensure that the data generated from epidemiology and virology are available as the basis for action by immunization programme managers and others responsible for implementing eradication strategies. EPI managers, clinicians, epidemiologists and virologists must work together as a team. The establishment and smooth functioning of these teams form an integral part of the overall polio eradication effort and provide a basis for strengthening EPI and related health unit efforts in other disease areas requiring laboratory support.

In 1989 a Plan of Action was formulated detailing laboratory support for global eradication of poliomyelitis. It described the activities needed to establish a three-tiered global network of laboratories, each with well-defined responsibilities. Considerable progress has been made. At all three levels of the network, and in all six WHO regions, Global Specialized, Regional Reference and National Laboratories are working together in the largest coordinated public health laboratory network ever.

In the initial stages of the establishment of this network, standardized methods were set out in a *Manual for the Virological Investigation of Poliomyelitis* (WHO/EPI.CDS/POLIO/90.1). The manual was distributed to potential network laboratories and formed the basis for training at WHO-sponsored courses and

---

during individual training attachments to reference laboratories. In response to changing requirements and lessons learned in establishing and developing the Global Polio Laboratory Network, the manual was revised in 1997 (WHO/EPI/GEN/97.01) and in 2001 (electronic distribution only).

In May 1999, the World Health Assembly reaffirmed the commitment of WHO to the eradication of poliomyelitis and urged all Member States to begin the process leading to the laboratory containment of wild poliovirus. The purpose of containment is to prevent wild poliovirus transmission from the laboratory to the increasingly non-immune community. In December 1999, WHO published the *WHO global action plan for laboratory containment of wild polioviruses (GAP)* (WHO/V&B/99.32) in preparation for global certification of eradication in 2005 and the eventual decline or cessation of global poliovirus immunization five to ten years later. The document is under revision and the second edition to be published in 2004 will incorporate lessons learned from biomedical laboratory surveys and inventories implemented in more than a hundred nations in five of the six WHO regions (WHO/V&B/03.11).

The revised GAP (GAP II) describes two phases of activities that are linked to the major eradication objectives.

The Laboratory Survey and Inventory phase covers the period when wild poliovirus continues to circulate. During this phase, nations will survey all biomedical laboratories to identify those with wild poliovirus infectious or potential infectious materials and encourage destruction of all unneeded materials. Nations will develop an inventory of laboratories that retain wild poliovirus and potential infectious materials and instruct laboratories on the inventory to institute enhanced biosafety level-2 (BSL-2/polio) measures for safe handling of materials. Nations will begin planning for Global Certification.

The Global Certification phase begins one year after detection of the last wild poliovirus anywhere in the world, at which time the probability is high that all human transmission will have ceased. In this phase nations will notify biomedical laboratories that wild poliovirus transmission has been interrupted. Additionally all laboratories on the national inventory will be contacted and instructed to select one or more of the following three options for containment: render materials non-infectious for poliovirus, or destroy them, under appropriate conditions; implement biosafety requirements appropriate for the laboratory activities being performed, i.e. BSL-2/polio or BSL-3/polio depending on whether polio replication procedures are to be performed; or transfer wild poliovirus infectious and potential infectious materials to laboratories capable of meeting the required biosafety standards where essential work can be continued. Nations must complete containment activities one year after notification of eradication and will document completion of all containment requirements for global certification of polio eradication.

GAP II states that post-Global Certification biosafety requirements will depend on decisions made about discontinuing universal polio immunization. If polio immunization is discontinued containment requirements for wild as well as oral polio vaccine (OPV) viruses are likely to become more stringent than those outlined above.

---

## 1.2 History of poliomyelitis and polio vaccines

Poliomyelitis is a disease of great antiquity. Perhaps the earliest description is evident in an Egyptian stele from around 1350 BC depicting a young man with typical asymmetric flaccid paralysis and atrophy of the leg. Several scattered reports of the disease also appear in the literature from the 17th and 18th century. By the mid-19th century, the Industrial Revolution had brought increased urbanization to Europe and North America and, with it, significant changes and improvements in living conditions. Coincident with these massive changes was the advent of larger and more frequent outbreaks of poliomyelitis. From the late 1800s, outbreaks were occurring in several European countries and in the United States, and they remained a dominant public health problem in the developed world for the first half of the 20th century.

A major landmark in the study of poliomyelitis was the successful passage of the virus to nonhuman primates by Landsteiner and Popper in 1909. The availability of animal models provided the first opportunity to study the disease outside of human patients and produced important information on the process of infection and the pathophysiology of the disease. Further studies on the infectious agent awaited the crucial development by Enders, Weller, and Robbins in 1949 of tissue culture systems for in vitro propagation of the virus. This advance, and the recognition of three distinct serotypes, opened the way for all subsequent work on vaccines and study of the biochemical and biophysical properties of the polioviruses.

By the 1950s, two different approaches to the prevention of poliomyelitis by vaccination were developed. Salk and Younger produced the first successful polio vaccine in 1954 by chemical inactivation of tissue culture-propagated virus using formaldehyde. This vaccine was completely non-infectious, yet, following injection, it elicited an immune response that was protective against paralytic disease. During the same period, many laboratories sought to produce live, attenuated polio vaccines. The OPV strains of Sabin were licensed in 1961 following extensive field trials in the former Soviet Union, Eastern Europe and Latin America. Mass immunization campaigns in many countries began in 1962 and 1963. Both the inactivated polio vaccine (IPV) and OPV contain three components, one for each immunologically distinct serotype of poliovirus. Some countries use enhanced IPV (eIPV) that contains higher D-antigenic units per dose for types 2 and 3 than standard IPV. Widespread immunization with IPV, and since 1963 with OPV, has virtually eliminated poliomyelitis in most developed countries.

## 1.3 Characterization of the pathogen

The polioviruses belong to the genus Enterovirus in the family Picornaviridae. All are small, round 30 nm particles with icosahedral symmetry, and they contain no essential lipid envelope. Polioviruses share most of their biochemical and biophysical characteristics with the other enteroviruses and are different from some of the other picornaviruses. The viral particles have a buoyant density of 1.34 g/ml in caesium chloride and a sedimentation coefficient of approximately 156S. The infectious particles are relatively heat resistant (when stabilized by magnesium cations), resistant to acid pH (pH 3 to 5 for one to three hours), and also resistant to

---

many common detergents and disinfectants, including common soap, non-ionic detergents, ether, chloroform, and other lipid solvents. The virus is stable for weeks at 4°C and for days at room temperature. Drying, ultraviolet light, high heat, formaldehyde, and free chlorine, however, readily inactivate the virus.

Polioviruses and the enteroviruses are distinguished from the other picornaviruses on the basis of physical properties such as buoyant density in caesium chloride and stability in weak acid. The three poliovirus serotypes are distinguished from the other enteroviruses by neutralization with serotype-specific antisera and the propensity to cause paralytic illness. The Mahoney strain of type 1 poliovirus is the prototype for the polioviruses, the genus enterovirus, and the family *Picornaviridae*. It is among the most-studied and best-characterized agents of human disease.

The poliovirus consists of 60 copies each of four polypeptide chains that form a very highly structured shell. Located inside this shell, the viral genome consists of a single molecule of ribonucleic acid (RNA), which is about 7500 nucleotides long. The four capsid polypeptides are produced by the proteolytic cleavage of a single polyprotein precursor, and are designated VP1 through VP4. Attached covalently to the amino-terminal of the VP4 protein is a single molecule of myristilate. In addition, one small protein, VPg, is covalently attached to the 5'-end of the viral RNA. A major advance in studies on the structure of polioviruses occurred with the solution of the crystal structure to a resolution of 0.29 nm. From the three-dimensional structure of the poliovirus, VP1 contributes the majority of the amino acid residues on the virus surface, VP2 and VP3 are partially exposed on the surface, and VP4 is completely internal.

The information concerning the surface of the virus has been particularly useful in understanding the neutralization of poliovirus by antibodies. Studies with monoclonal neutralizing antibodies and mutant viruses resistant to them have revealed four main antigenic sites on the virus. The relative importance of individual sites is different for each of the three serotypes of poliovirus. The X-ray crystal structure has confirmed that the antigenic sites are composed of amino acid residues located on the virus surface and exposed loops of capsid proteins. Adjacent domains of the same and other capsid proteins influence the conformation of the loops. This explains why antigenicity of the virus is destroyed by disruption of the virus structure. In addition, there are other antigenic sites that elicit an immune response that is not neutralizing.

The poliovirus-neutralizing antibody response is serotype-specific, with the exception of some minor cross-reaction between poliovirus 1 and 2. Heat-disrupted viruses, particularly those heated in the presence of detergent, induce antibodies that react with many enteroviruses. These broadly reacting antibodies are generally not neutralizing. Antisera raised in animals to each of the viruses are largely type-specific and are used for the determination of serotype in a neutralization assay. Although more than one T-cell epitope has been described in both structural and non-structural viral proteins, the role of cell-mediated immunity in controlling infection has not been determined.

---

Polioviruses are among the simplest viruses in terms of genetic complexity and size. The RNA genomes from all three serotypes of poliovirus have been cloned and sequenced. The genomic RNA is infectious and serves as messenger RNA for viral protein synthesis. The RNA is translated in a single open reading frame into one large polyprotein, which is then processed through proteolytic cleavage by two distinct virus-encoded proteases into the functional viral proteins (*Figure 1.2*).

Despite much research and the simple nature of the virus, several steps of the virus growth cycle have remained elusive, including the site and mode of virus entry and release of the genome into the cytoplasm. Polioviruses initially bind to a specific plasma membrane protein, the poliovirus receptor (PVR; CD155), a member of the immunoglobulin superfamily of proteins. The binding to the receptor triggers conformational changes in the capsid structure that are necessary for the release of the genome into the cytoplasm (uncoating). No other picornaviruses use this protein as their cellular receptor, a fact that has been exploited in the eradication programme by the use of a recombinant murine cell line expressing the human PVR to selectively isolate polioviruses.

Once the viral genome has entered the cell, the replication cycle begins when the viral RNA is transcribed by the viral polymerase beginning at the 3'-end of the infecting viral RNA to generate a complementary RNA (cRNA). In the next step, which is dependent on a "host factor", the progeny viral RNA is synthesized from the cRNA. The newly synthesized viral RNA is covalently linked to the VPg protein at the 5'- end of the RNA, and then only the positive sense strand of RNA is encapsidated in the viral structural proteins to form infectious viral particles. The extensive studies into virus replication and assembly have resulted in the remarkable accomplishment of complete cell-free replication of poliovirus beginning only with the viral RNA.

#### **1.4 Transmission of polio virus**

There are several routes of poliovirus transmission. In most developing countries the most important route is faecal-oral. The virus replicates efficiently in the intestinal tract and is typically shed in the stool for two to four weeks, and sometimes for several weeks longer. Shedding may be intermittent and is affected by the immune status and immune competence of the individual. Past natural infection with wild poliovirus and vaccination with OPV serve to significantly reduce the extent and duration of poliovirus shedding. Enhanced potency IPV and competing enteric infections may also reduce the extent and duration of stool shedding to a lesser degree.

Figure 1.2 Poliovirus genome

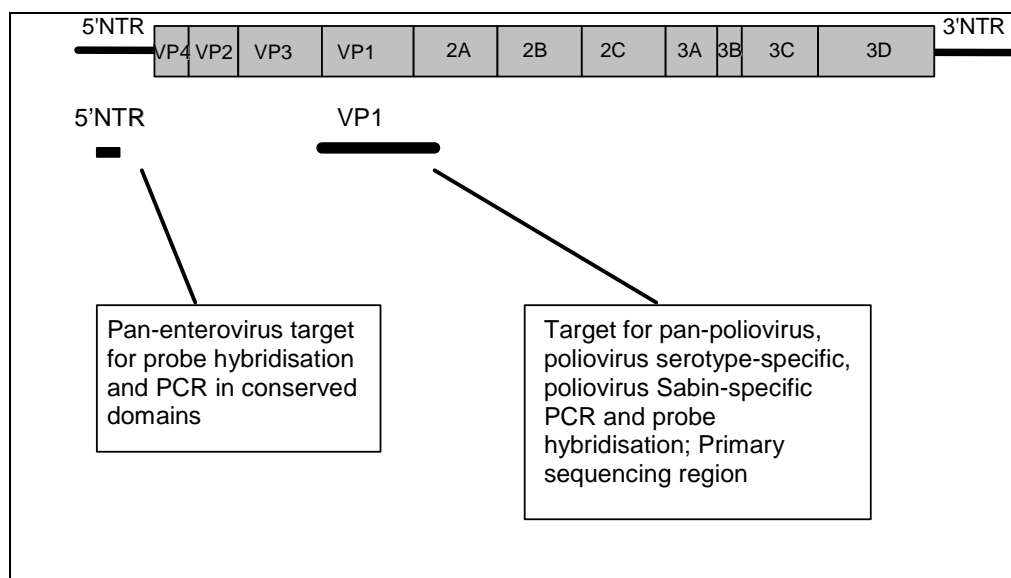

Factors that affect transmission of the virus include extent of crowding, levels of hygiene, water quality, and sewage handling facilities. In areas with good sanitary conditions and uncontaminated drinking water, other routes of transmission are probably more important. Since virus also replicates in the upper respiratory tract, polioviruses are spread through upper respiratory tract secretions as well. Virus can be recovered from throat swabs and washings during the early acute phases of infection. Studies with the non-polio enteroviruses suggest that respiratory tract secretions are infectious and may provide a source of virus for close contact spread through direct person-to-person contact, large-particle aerosols, or fomites.

In general, wild polioviruses (as contrasted with the vaccine-like polioviruses from OPV) have a distinct seasonal pattern of circulation that varies by geographic area. In tropical and semitropical areas circulation tends to be year round, or often associated with the rainy season. Prior to poliovirus immunizations, in temperate areas polioviruses were most prevalent in the summer and fall, although outbreaks may continue into the winter. Vaccine-like poliovirus can be found all the time in countries with routine use of OPV or cluster around the time of the NIDs.

An extremely powerful tool for tracking the circulation of wild poliovirus strains is the molecular characterization of the virus genomes from clinical isolates. Poliovirus mutates during its replication in the human intestine. The poliovirus replicase is error prone, with replication errors occurring at a relatively constant rate, leading to rapid evolution of the poliovirus genome (with 1% to 2% nucleotide substitutions occurring per site per year). By comparing the extent of genetic changes that are observed between virus strains, the geographic and temporal origin of a virus can be determined. Building upon a nucleic acid sequence database of poliovirus strains worldwide, it has been possible to develop rapid approaches to tracking wild poliovirus strains.



---

## *Vaccine-derived polioviruses*

Genetic differences distinguish OPV viruses from their parent strains and characteristic mutations are associated with attenuation of neurovirulence of parental strains. OPV strains can mutate during their replication in the human intestine and some mutations may result in recovery of the capacity for higher neurovirulence and lead to vaccine-associated paralytic poliomyelitis (VAPP). VAPP is a rare event that occurs in approximately one in every 2.5 million vaccine recipients.

A variety of OPV-derived viruses can be isolated from OPV recipients and their contacts, most commonly in the absence of paralytic conditions. The extent of sequence divergence of the VP1 capsid gene from Sabin strains can be used as a “molecular clock” to estimate the duration of poliovirus replication. In principle all clinical and environmental poliovirus isolates that are related to OPV strains are vaccine-derived poliovirus (VDPVs). Derivatives of Sabin OPV strains, however, have been classified into two broad categories for programmatic reasons:

**“OPV-like viruses”:** The vast majority of vaccine related isolates are “OPV-like” and have close sequence relationships (>99% VP1 sequence identity) to the original OPV strains. Immunologically normal OPV recipients usually excrete viruses for an average of three to four weeks. Short excretion periods and high population immunity normally limit the person to person spread of these OPV-like viruses.

**“Vaccine-derived polio viruses”:** Rare VDPV isolates show  $\leq$ 99% VP1 sequence identity to the parental Sabin strains and the extent of their genetic changes is indicative of prolonged replication. Two categories of VDPV isolates have been identified: immunodeficient VDPVs (iVDPVs) and circulating VDPVs (cVDPVs).

**iVDPVs:** The potential for prolonged replication of vaccine strains in patients with B cell immunodeficiencies has been recognized for many years. The first iVDPV isolates to be characterized with modern molecular techniques were from patients with either common variable immunodeficiency or X-linked agammaglobulinemia. Some iVDPV isolates have approximately 90% VP1 sequence identity to parental OPV strains, suggesting persistence of chronic poliovirus infections for 10 years or more. Eighteen chronic iVDPV excretors were detected worldwide through the end of 2002, although this number may be an underestimate in the absence of systematic screening of immunodeficient patients. There is no evidence of spread of iVDPVs from chronically infected persons to the wider community.

**cVDPVs:** The first evidence of the public health importance of cVDPVs was the outbreak of 21 confirmed polio cases (including two fatal cases) associated with type 1 cVDPV on the Caribbean island of Hispaniola in 2000–2001. Person-to-person transmission of VDPVs was suspected when the first two outbreak isolates were found to be distinct and 2-3% divergent in the VP1 sequence from the parent Sabin 1 OPV strain, yet related to each other. More limited cVDPV outbreaks have been detected in the Philippines in 2001 (associated with type 1 cVDPVs) and Madagascar in 2002 (associated with type 2 cVDPVs). A fourth outbreak was recognized from retrospective evidence of widespread circulation of type 2 cVDPV in Egypt in the 1980s and up to the early 1990s.

---

A common factor to all cVDPV outbreaks has been low population immunity, consistent with low OPV coverage and the apparent absence of circulating indigenous wild poliovirus of the same serotype. Other risk factors appear to be the same as for typical wild virus circulation and include crowding, high birth rates, poor hygiene and sanitation and tropical climate. All outbreak-associated cVDPV isolates described thus far have been recombinants with other species C enteroviruses. This observation, however, does not necessarily indicate that recombination plays an obligatory mechanistic role in the phenotypic reversion of OPV. Poliovirus recombination with other enteroviruses is an outcome of mixed infection, with the frequency of recombination being a function of the enterovirus carriage rate and the total number of mixed infections. It is becoming increasingly clear that any poliovirus that is circulating will eventually recombine with another related enterovirus of the same species, and that recombination is an indicator of circulation rather than necessarily a step in the increased ability to transmit from person to person. Therefore, given these correlations and uncertainties, if a vaccine-related isolate has significant divergence in its capsid nucleotide sequences (>1% from the parental OPV strains) and has evidence of recombination with group-C non-polio enteroviruses, it is likely to be a cVDPV, and the associated case should be investigated further.

---

## 2. Role and function of the laboratory in polio eradication

The key role for the Polio Laboratory Network is to provide virological information that can be used to target and focus resources on eradicating and, in the case of importations, containing the spread of wild polioviruses.

The role of the laboratory in polio-endemic countries is to provide timely and accurate information on the circulation of wild polioviruses that can be used to guide and focus immunization activities to achieve eradication of the virus. In countries where transmission of wild poliovirus has ceased, the role of the laboratory is to provide timely and accurate information on wild polioviruses imported from remaining polio-endemic countries and to make available documented virological evidence that will permit certification of polio eradication. In all countries the polio laboratory must work in close conjunction with the national polio eradication team, responding to their requirements for accurate and rapid laboratory diagnosis of suspected polio cases.

### 2.1 Appropriate investigations

*A Plan of Action for Global Poliomyelitis Eradication* was endorsed by the World Health Assembly in 1990 and revised in 1996 (WHO/EPI/GEN/96.03). It describes priority activities in the areas of immunization, surveillance and laboratory investigation for countries at different stages of progress towards polio eradication.

The priority laboratory activity is virus isolation from stool samples, appropriately collected and transported to the laboratory from as many acute flaccid paralysis (AFP) cases as possible. All poliovirus isolates should be serotyped by the National Polio Laboratory and referred to a WHO Reference Laboratory for intratypic differentiation as quickly as possible. In order to provide virological information to drive the immunization activities and allow targeting of resources, all wild poliovirus isolates must be submitted for genomic sequence analysis as soon as possible after identification.

In countries with no detected cases of polio for at least a year, each wild poliovirus case must be considered as a national public health emergency with immediate detailed and expert investigation. It is essential that intratypic differentiation be carried out promptly on all poliovirus isolates, and the results reported to the National Polio Programme. Isolation of a wild poliovirus must be reported immediately to the National Polio Programme and to the WHO Regional Office, and arrangements made for the isolate to be transported to a Global Specialized Laboratory (GSL) for genomic sequence analysis.

---

In order for a country to be certified as having eradicated wild poliovirus, it will be necessary to meet strict criteria of case finding and investigation. No wild poliovirus will have been detected over a three-year period in paralysed or healthy children or in the environment. Laboratories will be called upon to provide detailed records of their investigations and documented evidence proving their adherence to expected performance standards, resulting in their annual accreditation. All poliovirus isolates, regardless of origin, must be subjected to intratypic differentiation by WHO-approved methods in a WHO-accredited laboratory to demonstrate that they are not wild polioviruses.

Testing for polio neutralizing antibodies is not recommended for routine use in the diagnosis of poliomyelitis. It has rarely been useful in clarifying questionable virus diagnoses and requires additional field and laboratory time. Interpreting serum antibody titres is difficult with widespread immunization, and the method does not differentiate between antibodies against wild and vaccine strains.

## 2.2 Structure and activities of the WHO polio laboratory network

The WHO Laboratory Plan of Action outlines the strategies and activities for ensuring the availability of competent laboratory services to all countries and describes the structure and responsibilities of the three levels of institutions which comprise the network: National Laboratories (NL), Regional Reference Laboratories (RRL) and Global Specialized Laboratories (GSL) (*Figure 2.1*). In some countries, sub-National laboratories have been established. These laboratories carry out some or all of the activities of a NL, and are expected to perform to the same standards as a NL.

**Figure 2.1: Structure of the Global Polio Laboratory Network**

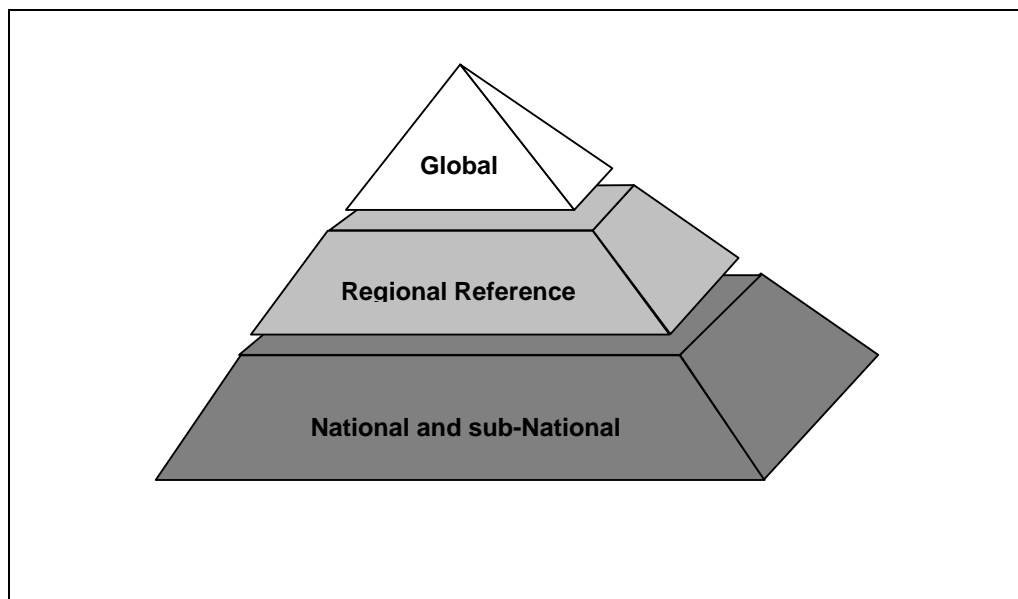

All laboratories undergo a process of annual accreditation documenting that the laboratory has the capability and capacity to fulfil its role in polio eradication.

---

### ***2.2.1 Responsibilities of National Laboratories***

The main responsibilities of NLs are:

- isolation and identification by serotype of polioviruses from faecal samples, using standardized procedures and reagents;
- referral of poliovirus isolates to RRLs;
- reporting results;
- coordination with EPI case investigators;
- coordination and implementation of containment activities.

### ***2.2.2 Responsibilities of Regional Reference Laboratories***

The main responsibilities of RRLs are to:

- serve as NLs to their own countries and to other specified countries which do not have NLs;
- perform intratypic differentiation of poliovirus isolates from the region;
- distribute reference materials such as appropriate cell lines and antisera;
- serve as centres for training courses and for training individual laboratory workers from countries in the region;
- coordinate quality control and validation of NLs in the region by managing the proficiency testing programme, and being available to visit, as necessary, when performance problems arise;
- refer selected poliovirus isolates to the GSLs for genomic sequence analysis;
- report results in a timely manner;
- coordinate and implement containment activities;
- coordinate with Expanded Programme on Immunization (EPI) case investigators.

### ***2.2.3 Responsibilities of Global Specialized Laboratories***

A limited number of laboratories function in the Network as GSLs. Their responsibilities include:

- definitive identification of poliovirus isolates using all available technologies, including genetic characterization, to reveal the origin of isolates;
- preparation and distribution of relevant standards, reference reagents and training materials;
- preparation and distribution of proficiency test panels;
- provision of consultants to evaluate and advise on laboratory services and to provide specialized training;
- participation in collaborative studies to assess proposed standards and reference materials;
- research aimed at improving the speed, sensitivity, specificity and applicability of methods for the diagnosis of poliovirus infection and for the detection of wild polioviruses in clinical and environmental specimens;
- reporting results in a timely manner;

- 
- coordination and implementation of containment activities;
  - coordination with EPI case investigators.

### **2.3 Coordination of the network**

Coordination of the polio laboratory network is carried out by WHO. Each of the WHO regions has a Regional Laboratory Coordinator responsible for the laboratories within their region. Each of the regions reports to the Global Laboratory Coordinator in WHO Headquarters, Geneva. Regular forward feeding of results, requests and queries, and feedback of analysis, comments and technical advice achieves coordination. Procurement and distribution of essential laboratory equipment and reagents is also effected through WHO. Linked in this way, the polio laboratory network is the largest public health laboratory network ever created.

#### ***2.3.1 Collection of specimens and transport to the laboratory***

Effective diagnostic virology depends upon the correct timing and collection of clinical specimens and their transport to the laboratory under optimal conditions. This requires close cooperation between virologists, epidemiologists and clinicians. Detailed planning, designation of responsibilities and training are needed. A typical process of collection and transport of specimens from field through the laboratory system is illustrated in Figure 2.2.

Figure 2.2: Flow-chart of specimen collection and transport

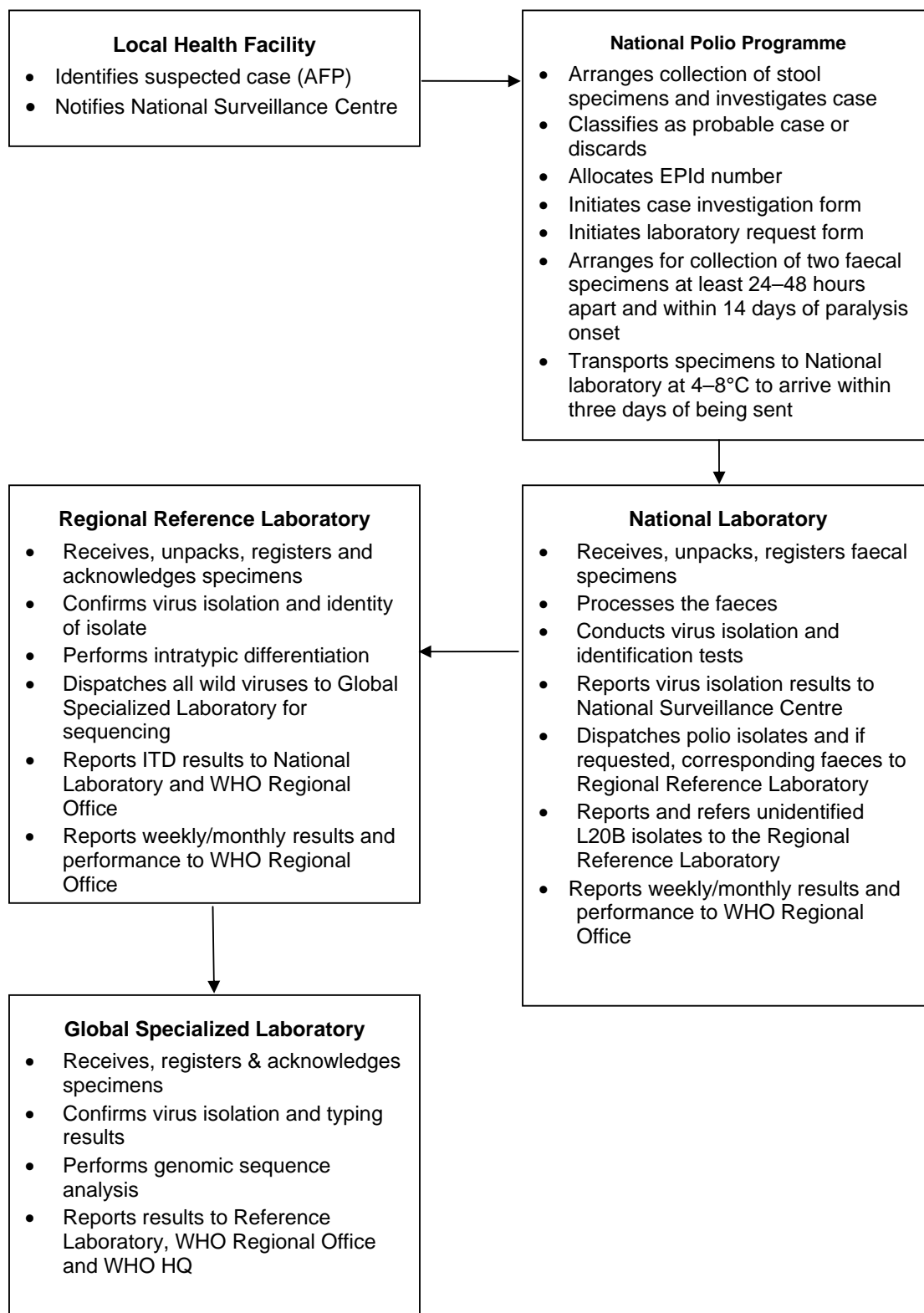

---

## 2.4 Accreditation of network laboratories

Accreditation provides documentation that the laboratory has the capability and the capacity to detect, identify, and promptly report wild polioviruses that may be present in clinical and environmental specimens. The accreditation process further provides a learning opportunity, a mechanism for identifying resource and training needs, a measure of progress, and a link to the Global WHO Laboratory Network.

Accreditation of National Poliovirus Laboratories is reviewed annually by the WHO Regional Office and is based on laboratory performance during the preceding 12 months, with complete data, usually from 13 months to one month prior to evaluation. Accreditation is given for the upcoming calendar year.

### 2.4.1 *Criteria for National and sub-National Laboratory accreditation*

There are seven criteria for accreditation of National and sub-National Laboratories within the Global Polio National Laboratory (GPNL).

- 1) **Test results are reported by the laboratory on at least 80% of acute flaccid paralysis specimens within 28 days of receipt.**

This criterion may be met for all virus-negative specimens after two passages in 14 days. Similarly, viruses that demonstrate cytopathic effect within the first week of incubation may be identified within the 28-day time frame. Viruses that appear late in passage, virus mixtures or viruses that present typing difficulties may require longer than 28 days.

- 2) **Virological tests are performed on at least 150 stool specimens annually.**

Fully active virus laboratories that maintain the appropriate cell cultures weekly and annually test 150 stool specimens of any origin for any enteric viruses are deemed to meet this criterion. Laboratories anticipating less than this number may collaborate with the EPI staff to develop protocols for sampling stools from children with aseptic meningitis, healthy children in high risk areas, or other epidemiologically sound virus surveillance activities.

- 3) **The accuracy of poliovirus detection and identification among all virus isolates is at least 90%.**

Accuracy is determined by the agreement in test results on all poliovirus isolates submitted by the NL to the RRL during the 12-month review period.

- 4) **At least 80% of poliovirus isolates from acute flaccid paralysis cases are forwarded to the Regional Reference Laboratory for intratypic differentiation within seven days of obtaining typing result.**

It is essential that the polio eradication programme be aware of all wild and suspected vaccine-derived poliovirus isolations as soon as possible. All poliovirus isolates from AFP, contacts and other suspected polio cases must be forwarded without delay to the RRL for intratypic differentiation. Polioviruses



---

from non-AFP sources or supplementary surveillance activities (e.g. polioviruses from environmental samples) should also be subjected to ITD tests and should be forwarded to reference laboratories as soon as possible (ideally within seven days of detection).

- 5) **Internal quality control procedures, including cell culture sensitivity, are implemented at least quarterly in accord with the WHO protocol.**

Ideally, cell line sensitivity should be known for all frozen stocks and evaluated whenever fresh cells are resuscitated or received in the laboratory. It is recommended that cells be evaluated at least midway through their expected use of 15 passages. Assessing sensitivity before discarding at 15 passages can reassure the laboratory that sensitivity has been maintained throughout the period of use, but is not essential for accreditation. Original quality control (QC) data sheets and summaries of corrective action are retained for documentation and discussion with the reviewer.

- 6) **The score on the most recent WHO approved proficiency test is at least 80%.**

Proficiency test (PT) results must be reported within 28 days of panel receipt to receive full credit.

- 7) **The score from the annual on-site review of laboratory operating procedures and practices is at least 80%.**

For laboratories with consistently high annual scores, the Regional Laboratory Coordinator may waive the on-site review upon satisfactory completion of the annual checklist by the laboratory.

**The annual non-polio enterovirus (NPEV) isolation rate from all stool specimens:** The NPEV rate *is not a criterion* for accreditation because of the variability of findings, which are influenced by a number of factors, including the season of the year, elevation, or population hygienic levels. However, the rate may be a useful indicator of laboratory performance and should be discussed with the reviewer. The annual NPEV isolation rate in most tropical countries typically exceeds 10%.

---

## 2.4.2 *Criteria for Regional Reference Laboratory accreditation*

There are five criteria for accreditation of RRLs:

- 1) **ITD test results are reported to the Programme and the Regional Laboratory Coordinator on  $\geq 80\%$  of all acute flaccid paralysis (AFP) poliovirus isolates within 14 days of receipt or completion of typing if specimens are processed in that laboratory.**

This criterion applies to poliovirus isolates from AFP cases and contacts. ITD tests should be performed on poliovirus isolates from all sources, but those from AFP cases and their contacts should be given highest priority.

- 2) **Wild poliovirus and suspected vaccine-derived poliovirus isolates from  $\geq 80\%$  of acute flaccid paralysis cases and contacts are referred for sequencing within seven days of detection.**

This criterion applies to isolates from AFP cases and contacts. It is essential that the Polio Eradication Programme be able to get information about the characteristics of wild poliovirus or VDPV isolates as soon as possible. Wild polioviruses and suspected VDPV isolates must be forwarded without delay to a Global Specialized Polio Reference Laboratory for sequencing.

- 3) **The score is  $\geq 90\%$  on the most recent WHO poliovirus intratypic differentiation proficiency test.**

PT results must be reported within 14 days of panel receipt to receive full credit.

- 4) **The score is  $\geq 90\%$  on the most recent WHO poliovirus isolation/identification proficiency test .**

PT results must be reported within 28 days of panel receipt to receive full credit.

- 5) **The score from the annual on-site review of laboratory operating procedures and practices is  $\geq 90\%$ .**

**For those that also serve as NLs:**

- 6) **Test results are reported to the programme on  $\geq 80\%$  of AFP specimens within 28 days of receipt.**

Viruses that appear late in passage, virus mixtures, or viruses that present typing difficulties may require longer than 28 days.

- 7) **Internal QC procedures for L20B and human rhabdomyosarcoma (RD) cell culture sensitivity are implemented at least quarterly in accordance with the WHO protocol.**

---

Ideally, cell line sensitivity should be known for all frozen stocks and evaluated whenever fresh cells are resuscitated or received in the laboratory. It is recommended that cells be evaluated at least midway through their expected use of 15 passages. Assessing sensitivity before discarding at 15 passages can reassure the laboratory that sensitivity has been maintained throughout the period of use, but is not essential for accreditation. Original QC data sheets and summaries of corrective action are retained for documentation and discussion with the reviewer.

#### ***2.4.3 Accreditation of selected National Laboratories to carry out intratypic differentiation***

Some NLs that test large numbers of AFP stool specimens from endemic or recently endemic areas have been requested by WHO to perform ITD tests on polioviruses isolated in the laboratory. Combining poliovirus isolation/ identification and ITD in the same laboratory can shorten wild virus and suspected VDPV reporting time by several weeks.

Supplemental accreditation provides documentation that the National Poliovirus Laboratory performing ITD tests has the capability and the capacity to detect, identify and promptly report wild polioviruses that may be present in any specimen. Full accreditation as a NL is a prerequisite for ITD accreditation. The accreditation process further provides a learning opportunity, a mechanism for identifying resource and training needs, a measure of progress, and a link to the Global WHO Laboratory Network.

#### ***2.4.4 Four criteria for supplemental accreditation:***

- 1) Intratypic differentiation test results are reported to the Programme and the Regional Laboratory Coordinator on  $\geq 80\%$  of all acute flaccid paralysis poliovirus isolates within 14 days of typing in the laboratory.**

This criterion applies to isolates from AFP cases and contacts of AFP cases from investigations. ITD tests should be performed on polioviruses isolated from all sources, but those from AFP cases and their contacts should be given highest priority.

- 2) The score is  $\geq 90\%$  on the most recent WHO poliovirus intratypic differentiation proficiency test .**

PT results must be reported within 14 days of panel receipt.

- 3) Wild poliovirus and suspected vaccine-derived poliovirus isolates from  $\geq 80\%$  of acute flaccid paralysis cases and contacts are referred for sequencing within seven days of detection.**

This criterion applies to isolates from AFP cases and contacts. It is essential that the polio eradication programme be able to get information about the characteristics of wild poliovirus or VDPV isolates as soon as possible. Wild

---

polioviruses and suspected VDPV isolates must be forwarded without delay to a Global Specialized Polio Reference Laboratory for sequencing

- 4) **The score from the annual on-site review of laboratory operating procedures and practices is  $\geq 90\%$ .**

#### ***2.4.5 Accreditation of Global Specialized Laboratories***

The specialized functions carried out by the GSLs are not equally distributed between the laboratories, with some laboratories being the sole provider of certain functions. All Global laboratories, however, perform the roles of RRLs, and several also act as NLs. It is therefore most appropriate to accredit the GSLs using the criteria for RRLs, but expecting a more than adequate level of performance. These laboratories are regarded as centres of excellence, and should be expected to be able to provide a performance compatible with expectations.

#### ***2.4.6 Category of provisional accreditation***

The additional category of “provisionally accredited” should be used for laboratories that achieve a passing score in the proficiency panel test, but fail to meet one of the remaining criteria. Provisional accreditation is given at the discretion of the Regional Laboratory Network Coordinator. In such cases the laboratory, in conjunction with the reviewer and the WHO Regional Office, must develop a detailed plan of action to resolve problems within one year. The laboratory must receive another accreditation review visit by the end of that year. A laboratory that again fails to meet all accreditation criteria cannot be given provisional accreditation status for a second year in succession. Such laboratories must be given the status of “not accredited”, and an accredited laboratory must confirm the test results on all specimens from AFP cases that are reported by the non-accredited laboratory.

#### ***2.4.7 Laboratories that fail to be accredited***

A laboratory that achieves less than the passing score on any one of the applicable criteria will work with the Regional Laboratory Coordinator to:

- identify areas where improvement is needed;
- develop and implement a work plan;
- monitor laboratory progress;
- provide for retesting where required;
- continue steps to achieve full accreditation.

The aim of every laboratory should be to achieve full accreditation. However, if a laboratory has passed the most recent proficiency test but failed to reach one of the other performance criteria (reporting time, number of specimens tested, confirmation of isolates, internal QC, review of operating procedures and work practices) it may be considered for provisional accreditation. The Regional Laboratory Coordinator can make the decision to award provisional accreditation status.

---

A laboratory that fails to achieve a passing PT test score within six months of an annual review is deemed non-accredited and arrangements must be made for an accredited Laboratory to perform duplicate tests on all specimens.

Laboratories that repeatedly fail to achieve accreditation status pose a problem for the Programme. In some instances, with the agreement of the national government and the WHO Regional Director, these laboratories can be excluded from the Global Polio Laboratory Network. In other instances, however, it will not be possible to exclude laboratories, and attempts must continue to be made to improve laboratory performance by providing support through consultant visits and laboratory staff training. In these cases, arrangements must be made for an accredited laboratory to confirm all results on specimens from AFP cases reported by the non-accredited laboratory. These arrangements should be viewed as long-term and may require provision of additional support for the laboratory and for specimen transport.

#### ***2.4.8 Responsibilities for accreditation of laboratories***

**National and sub-National Laboratories:** Accreditation of National and recognized sub-National laboratories is the responsibility of the WHO Regional Offices. Ideally, all national and recognized sub-national laboratories should be visited by the Regional Polio Laboratory Network Coordinator at least once a year. Where this is not possible, laboratory consultants or other experts should visit the laboratories on behalf of WHO. These visits should be combined with the annual accreditation review visit.

**On completion of an accreditation review the WHO Regional Office should be informed of the result. It is the responsibility of the Regional Office to make an official announcement of the accreditation review result. The Regional Office should report the result to:**

- the national authorities through the office of the WHO Representative;
- the head of the national surveillance or EPI programme;
- the director of the institute hosting the laboratory;
- the head of the laboratory;
- the WHO Global Laboratory Network Coordinator.

**Regional Reference Laboratories:** Accreditation of Regional Reference Laboratories (RRLs) is the responsibility of WHO Headquarters. Ideally, the WHO Global Laboratory Network Coordinator, accompanied by the Regional Laboratory Network Coordinator, will make accreditation review visits to all RRLs. Where this is not possible the Regional Laboratory Network Coordinator accompanied by a representative acting on behalf of WHO/HQ should make the visit.

---

On completion of an accreditation review WHO Headquarters should be informed of the result. It is then the responsibility of the WHO Headquarters to make an official announcement of the accreditation review result. The result should be reported to:

- the WHO Regional Office;
- the director of the institute hosting the laboratory;
- the head of the laboratory.

**Global Specialized Laboratories:** Accreditation of Global Specialized Laboratories (GSLs) is the responsibility of WHO Headquarters.

On completion of an accreditation review WHO Headquarters should make an official announcement of the result to:

- the WHO Regional Office;
- the director of the institute hosting the laboratory;
- the head of the laboratory.

#### ***2.4.9 Requirements for accreditation review visits***

National and recognized sub-national laboratories that have been fully accredited and continue to meet WHO laboratory performance criteria need not receive an accreditation review visit every year. In these cases the laboratory can be accredited by the Regional Laboratory Network Coordinator on the basis of:

- at least 80% of test results reported within 28 days;
- at least 150 specimens tested annually;
- at least 90% of poliovirus isolates confirmed by the Regional Reference Laboratory;
- at least 80% of AFP poliovirus isolates forwarded for ITD within seven days;
- at least 80% scored on the most recent WHO-approved proficiency test;
- internal quality control procedures implemented at least quarterly.

Under these circumstances the WHO Regional Office should inform the following that the laboratory has been fully accredited for the coming year and that because of continued high quality performance no accreditation review visit is necessary:

- the national authorities through the office of the WHO Representative;
- the head of the national surveillance or EPI programme;
- the director of the institute hosting the laboratory;
- the head of the laboratory; and
- the WHO Global Laboratory Network Coordinator.

The decision not to carry out the accreditation review visit is at the discretion of the Regional Laboratory Network Coordinator. It is expected, however, that even a high performance national and recognized sub-national laboratory should receive at least one accreditation review visit every three years.

---

# 3. Laboratory quality assurance

## 3.1 The basis of laboratory quality assurance

Laboratory Quality Assurance (LQA) is concerned with the organizational processes and the conditions under which laboratory activities are planned, performed, monitored, recorded and reported. Adherence by laboratories to the principles of LQA ensures the proper planning of activities and the provision of adequate means to carry them out. It promotes full and accurate reporting, and provides a means whereby the integrity of the activities can be verified.

Setting up a LQA system in a laboratory means defining the organizational structure, responsibilities, procedures, processes and resources necessary to achieve the following objectives:

- prevent risks;
- detect deviations;
- correct errors;
- improve efficiency;
- ensure data quality and integrity.

It is the responsibility of the Director or Chief of the Laboratory to establish, implement and ensure compliance with LQA. However, LQA is the responsibility of all laboratory personnel.

There are a number of elements that make up the LQA process, which are detailed below.

### 3.1.1 *Staff*

The polio laboratory should have the necessary staff with suitable qualifications and experience to carry out safely and accurately all the functions and responsibilities required of the polio laboratory. The laboratory should prepare an organigram of the polio laboratory that reflects the hierarchy and lines of authority, and include the functions and responsibilities of each person.

Staff should include:

- director or chief of the laboratory;
- head of each section or unit if appropriate e.g., cell culture, intratypic differentiation laboratory, etc.;

- 
- scientific, technical and auxiliary staff;
  - administrative support, maintenance, cleaning and service staff.

Each post should have a job description including functions and responsibilities, academic training required and experience necessary.

### ***3.1.2 Staffing levels***

Staffing levels should be adequate to enable all the functions expected of the polio laboratory to be carried out without compromising safety or the integrity of the processes performed in the laboratory. There are specialized activities within the laboratory that require staff with considerable experience, such as cell culture production, reading of cytopathic effect in virus cultures, performing intratypic differentiation and sequencing. There should be at least one person with at least 12 months relevant experience to carry out these activities. It is advisable for at least one other person to work together with the experienced person to gain understanding of the activity and build capacity within the laboratory and allow for backup in the event of staff absence.

### ***3.1.3 Human resources***

The fundamental objective of the human resources policy is to have reliable staff with scientific and/or technological training to apply appropriate laboratory procedures correctly, and remunerated according to the labour market. The laboratory must regularly arrange and coordinate training courses to extend and update the skills of both technical and scientific staff according to needs identified and as proposed by the heads of department. This training is offered as a means of contributing to the success of the LQA process. A continuing education programme must be developed which includes on-site as well as external training. Documentation should be kept describing the staff training programme.

The human resources programme should include the technical evaluation of staff and follow-up of the performance of each staff member based on the job description. This system allows the correction of errors or weaknesses, and can also be used as a tool for promotion, where merited.

### ***3.1.4 Space allocation***

The polio laboratory should have adequate space to safely perform all activities, store all necessary equipment and allow for easy cleaning and maintenance. There should be enough rooms to enable separation of infectious from non-infectious activities. Cell culture and media-making facilities should be separated as much as possible from all other activities and preferably be in a room(s) completely separated from the laboratory where viral or other microbiological activities are being carried out. There should be a clear delineation of different working areas to minimize the chances of contamination of clean areas. If possible, there should be a logical arrangement of activities in a laboratory or laboratories to minimize the distance infectious materials must be carried and to ensure that infectious materials are not being transported through clean areas. If space allows, specific areas and preferably specific rooms should be allocated for:



- 
- reagents and consumables storage;
  - instruments and equipment;
  - washing, preparation and sterilization (clean and dirty);
  - cell culture;
  - specimen receipt and recording;
  - specimen processing;
  - inoculation, harvesting and typing;
  - specialized activities;
  - documentation, archiving and control;
  - the administrative area;
  - disposal of contaminated and medical wastes.

The following are the general characteristics with which the laboratory areas should comply:

- Lighting and ventilation should correspond to the needs of each working area, according to the specific requirements of the activity carried out. The surfaces of the workbenches should be smooth, easy to clean and made of material resistant to chemicals.
- Safety systems should cover fire, electrical emergencies, emergency shower and eyewash facilities.
- Hot and cold water, treated water, vacuum, gas, steam and electricity installations should be arranged so that they guarantee adequate use during the work and also facilitate maintenance and repair operations. Electrical installations should be arranged so that they do not pose any risk to workers, and electrical wires should not cross walkways. A standby generator is desirable for the support of essential equipment such as incubators, biological safety cabinets (BSCs), freezers etc., especially if power supply is erratic.
- Storage space must be adequate to hold supplies for immediate use and thus prevent clutter on bench tops and in aisles. Additional long-term storage space conveniently located outside the working areas should also be provided.
- Hand washbasins, with running water if possible, should be provided in each laboratory room, preferably near the door.
- An autoclave should be available in the same building as the laboratory.
- Facilities for storing outer garments and personal items, and for eating and drinking, should be provided outside the working areas.
- Installation of equipment and organization of the laboratories should take biosafety and other safety standards into account.

### **3.2 Standard operating procedures**

Standard operating procedures (SOPs) describe in detail the activities performed in the laboratory so as to:

- provide uniformity, consistency and reliability in each of the activities performed in the laboratory;

- 
- reduce systematic errors;
  - provide training and guidance for new staff.

Standard operating procedures should be drawn up by specialized technical staff in the laboratory, revised by their immediate supervisor and approved by the Director of the laboratory.

Standard operating procedures should be prepared for general procedures, for example:

- **General:** preparation of SOPs, correction of notes and documentation, preparation of protocols, reports.
- **Test systems:** preparation of work areas, maintenance of work areas.
- **Laboratory operations:** receipt, recording and labelling of samples, washing of recyclable apparatus, sterilization of material, storage of samples, labelling of materials and reagents, preparation of media and solutions.
- **Staff-related matters:** training, handling of hazardous materials, laboratory safety, staffing of each laboratory subunit.
- **Reference materials:** identification, characterization, handling, reception, storage, use.
- **Archives:** maintenance, distribution and updating.
- **Equipment:** regular calibration, cleaning, preventive maintenance.
- **Test methods:** methods for processing and testing samples sent to a laboratory. They should closely follow the WHO recommended procedures and be drawn up according to the following the format shown in Figure 3.1.

An example SOP is shown in Figure 3.2. An example of a flow-chart for use with an SOP is shown in Figure 3.3.

---

**Figure 3.1: Layout – standard operating procedure**

**Title:** Descriptive

**Code:** This code will identify:

- the laboratory;
- the number relating to each procedure;
- the number that identifies the revisions, with 00 being used for the original document.

**Objective:** The aim of the procedure being described should be expressed clearly and concisely.

**Scope:** Name the operating unit that will apply the procedure, and the field of application of the procedure.

**Definitions:** The meaning of the principal terms used in the procedure should be stated.

**General description:** Each SOP should be drawn up clearly, without ambiguity, so that it can be understood by staff with and without experience. Each step for performing the activity that is regulated by the procedure should be described in detail. Flow diagrams may be used to complement the description.

**Safety conditions:** These should reflect the safety measures and conditions to be kept in mind for the correct execution of the SOP. Material Safety Data Sheets should be included for hazardous chemicals used.

**Documentation:** The form or protocol in which the data and measurements involved in the procedures should be recorded.

**References and documents:** The references used to draw up the SOP.

**Figure 3.2: Example – standard operating procedure**

**Title: Cell Culture Media Preparation**

**Code:**

- **The laboratory:** name of laboratory
- **The number relating to procedure:** 3
- **The number that identifies the revisions:** 3.00 (original document), 3.01 would be first revision, 3.02 second revision, etc.
- **Date:** date of issue of this version
- **Author(s):** Dr ..... ..

**Objective:** To describe Cell Culture Cell Media and its preparation for each of the two Cell Culture Cell Lines in the Cell Culture Laboratory.

**Scope:** This document contains the processes that are common to the Cell Culture Laboratory of the Polio Laboratory in the XXXXX Institute.

**Definitions:**

- RD refers to human Rhabdomyosarcoma cell line sensitive to poliovirus and many other enteroviruses.
- L20B refers to a cell line derived from a mouse L cell transfected with polio receptors that will selectively support the growth of Poliovirus but very few other enteroviruses.
- MEM: Eagles Minimum Essential Medium (Earle's Salts base).
- PBS: Phosphate Buffered Saline.

**General description:**

Detailed account of activities of SOP.

**Safety conditions:** All safety guidelines will be followed throughout, including biosafety, chemical safety and disposal guidelines.

**Documentation:**

- Media type
- Manufacturer
- Catalogue number
- Lot number
- Expiry
- Date received
- Date prepared
- Volume prepared
- Prepared by
- QC results
- Expiry date of prepared media
- Storage
- Date used
- Other comments

References and documents used to draw up SOP: *WHO Polio Laboratory Manual*.

Figure 3.3: Example – standard operating procedure flow-chart

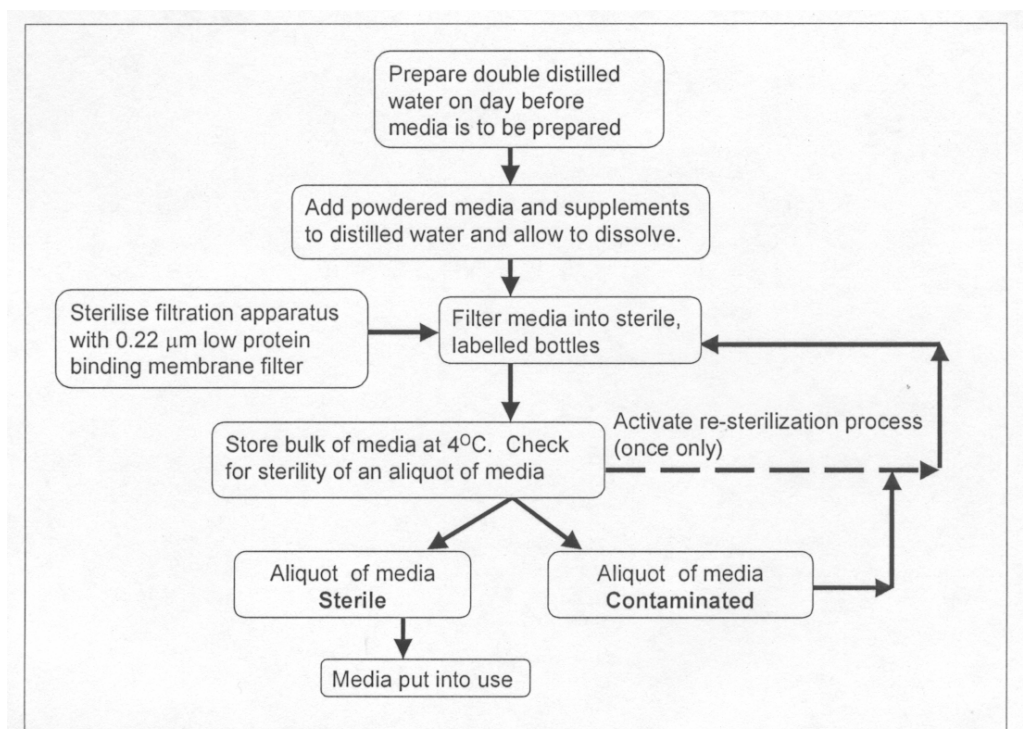

Each SOP should have the following on each page:

- logo and name of the organization;
- department or unit issuing the SOP;
- title;
- signature of person who drew up the SOP with date (day, month and year);
- signature of person who reviewed it with date (day, month and year);
- signature of person who authorized it with date (day, month and year);
- duration of validity;
- date of review;
- code;
- page number and total number of pages in the document.

Changes in a SOP should be implemented by specialized technical staff in the laboratory, revised by their immediate supervisor and approved by the Director of the laboratory. Any method that undergoes changes from the standard and official method should be validated before being put into practice, by comparing the following characteristics with the previous method:

- 
- **accuracy:** degree of correlation with the value achieved by the previous method;
  - **precision:** the variation of the results as represented by the standard deviation or the coefficient of variation;
  - **sensitivity:** capacity of the test procedure to record small variations between concentrations;
  - **reproducibility:** the precision of the procedure when it is performed under different conditions;
  - **specificity:** the degree of uniformity of the response to the substance in question;
  - **robustness:** ability to provide accurate and precise results under a variety of conditions.

### 3.3 Documentation

Documentation is the set of quality manuals, standard operating procedures, instructions, forms, reports, analytical protocols and record of data that serve as evidence of the LQA and permit the traceability of data.

Responsibility for the preparation and revision of documents should rest with the LQA or Quality Assurance department, or with the person appointed, depending on the complexity of the laboratory.

### 3.4 Equipment and instruments

The laboratory should have the necessary equipment and instruments for the accurate performance of all tests performed. The standard list of equipment for WHO polio laboratories is listed in Table 3.1. New instruments and equipment should be installed and calibrated if possible by the distributor or a suitably qualified person. All manuals and operating instructions should be stored in an area accessible to all users and a regular maintenance and calibration schedule established. All users should be completely familiar with the operating, maintenance and validation procedures to ensure correct functioning. Documentation of all malfunctions, maintenance and validation activities should be recorded in a central register.

The laboratory should have a list of equipment and instruments that include:

- the name;
- brand;
- donor or supplier;
- maintenance company;
- maintenance schedule;
- inventory number;
- serial number;
- model and year;
- location;
- date of purchase;

- 
- date of first use;
  - copy of manufacturer's handbook.

### 3.5 Supplies

#### 3.5.1 *Reference materials*

These comprise material used to calibrate the test procedures and to guarantee uniformity in determining activity such as reference Sabin strains for sensitivity testing of cell lines, or validation of typing antisera.

A central registry or logbook should be kept containing the following:

- name of the reference material;
- supplier;
- origin;
- lot number;
- date of analysis to determine whether it complies with the stipulated requirements;
- place and conditions of storage;
- expiry date, where applicable;
- storage in an appropriate form (corresponding SOP).

This registry should contain all the information relating to the properties of the reference material.

The quality of the reference material should be verified (a) when the conditions have been altered and (b) routinely, once a year.

**Table 3.1: Basic laboratory equipment**

Items	Recommended	
	Quantity	Approx cost (US\$)
Autoclave, large, (or bench top for small lab)	1	14000 (1000)
Balance, with power adapter	1	1295
Cabinet, class II safety and replacement filter	2	7000
Centrifuge, low speed, refrigerated	1	7710
Computer, with software	1	1700
Counting chambers	2	180
Pipettors, 100–1000 µl	2	400
Displacement pipettes, 20–200 µl	2	300
Dispenser, repeated	2	200
Fax machine	1	600
Freezer, -20°C, household, non-frost free, chest type	2	1200
Incubator, standard	2	6400
Liquid nitrogen container, 25 litres for reserve nitrogen	1	2600
Liquid nitrogen storage system — low evaporation	1	1930
Media filtration system and accessories	2	3255
Meter, pH, hand held with spare electrodes	1	610
Microscope, inverted	2	3530
Microscope, standard	1	1670
Mixer, vortex	1	200
Oven, hot air sterilizing	1	580
Refrigerator, household, 4°C	2	1200
Stirrer, heated, magnetic with bars	1	300
Storage system for chest freezer	1	600
Test tube rack for 16 mm tubes	12	315
Thermometers	12	85
Thermometers, 0–100°C	6	300
Water distiller, double or triple, glass	1	2500
Water deionizer (cartridge)	1	2650
Water bath	1	865



---

### 3.5.2 Reagents

Reagents can be defined as materials of chemical or biological origin used in laboratory assays. The standard list of reagents and supplies recommended (per 100 samples) for WHO polio laboratories is shown in Table 3.2. At least a six months' reserve stock of reagents should be held in the laboratory at all times. Given the long delivery times and difficulty of transport to some regions, reagents should be ordered 6 to 12 months ahead of need. Cell culture medium should be considered a reagent.

A central registry or logbook should be kept containing the following:

- name of the reference material;
- supplier;
- origin;
- lot number;
- date of analysis to determine whether it complies with the stipulated requirements;
- place and conditions of storage;
- expiry date, where applicable;
- storage in an appropriate form (corresponding SOP).

This registry should contain all the information relating to the properties of the reference material.

The quality of the reference material should be verified (a) when the conditions have been altered and (b) routinely, once a year.

Characteristics of reagents:

- They should be of appropriate quality.
- They should be obtained from recommended suppliers in their original packaging.
- A record should be kept of purchase, reception and distribution to guarantee continuity, particularly with substances that need to be acquired in advance.
- The reagents should be inspected to ensure that the seals are intact when received in the stockroom or when distributed to the laboratory. These inspections should be recorded with the initials of the person responsible for the inspection and the date written on the label.
- There should be a specific SOP for the transport, storage and handling of reagents and disposal.

Any changes to the composition of reagents or media or to the lot numbers of biological products (antisera, conjugates etc.) should be fully documented in the central registry or logbook.

**Table 3.2: Supplies and reagents for testing 100 specimens for poliovirus isolation**

Items	Recommended		
	Quantity	Approximate cost (US\$)	
Bottles	60 ml	20	260
	250 ml	20	150
	125 ml	20	110
	500 ml	20	280
	1 L	20	140
Bulbs (pipette filters)		1 pk/12	50
Cryovials	(2 ml)	500	108
	(4 ml)	500	270
Cylinders, graduated	500 ml	10	70
Cylinders, graduated	100 ml	10	35
Pipette, serological,	1 ml	200	50
	2 ml	200	70
	5 ml	200	100
	10 ml	200	125
Pipette, 25 ml, glass		10 0	190
Pasteur Pipette		1 pk/1000	30
Beads, glass		1 kg	80
Chloroform		2 liters	75
DMSO 5x5 ml ampoules		3 pk of	65
Flask, TC, 75 cm <sup>2</sup>		1 case/500	440
Flask, TC, 25 cm <sup>2</sup>		1 case/500	340
Fungizone		30 pk	220
Gloves, latex disposable, medium		100 pairs	270
Glutamine		200 g	100
Hanks BSS		10 liters	60
MEM/HEPES		10 liters	100
Microtiter plates (flat bottom, sterile)		50 plates	150
Microtiter plate seals		100	28
PBS		1 liter	30
Penicillin/streptomycin		40 pk	190
Phenol red		25 g	40
Pipettor tips (ARTs), disposable, 2–20 µl		1000	
Pipettor tips (ARTs), disposable, 10 µl		1000	75
Pipettor tips, (ARTs) disposable, 200 µl		1000	90
Single Channel variable volume 2–20 µl		2	600
Multi Channel variable volume pipettor		2	1400
Variable volume pipettor 20–200 µl		2	200
Variable volume pipettors 100–1000 µl		2	200
Serum, fetal bovine		3 liters	900
Sodium bicarbonate		1 kg	20
Trypan blue		1 pk	10
Trypsin lyophilized		30 pk	165
Tubes, TC, 16x125 mm		2 cases/500	315
Tube caps for TC		1000	35
Tubes, 15x85, sterile, capped		1000	140
Tubes, centrifuge (chloroform resistant 15 ml)		100	85
Versene (EDTA)		100 ml	50
Wooden spatulas		200	10

---

Water should be considered a reagent and should comply with purity specifications or other technical requirements for use in the laboratory. Reagents prepared in the laboratory should be prepared in conformity with written procedures and, where applicable, according to WHO standard recommendations, validated and labelled appropriately, stating the following:

- identification of the reagent;
- concentration;
- preparation and expiry date;
- storage conditions;
- initials of the technician responsible.

### 3.5.3 *Cell cultures*

Cell lines or cultures should comply with specifications indicating the number of subcultures, the incubation temperature, recommended media and splitting process. They should be free from contamination. Cell cultures prepared in the laboratory should be according to written procedures, and documented with the following information:

- identification of cell culture;
- source and date of receipt;
- passage number;
- growth medium;
- maintenance medium;
- seeding concentrations;
- storage.

### 3.5.4 *Virus strains*

These are standard viral strains obtained from a WHO-designated supplier and used in the evaluation of virological methods. They should be under the responsibility of experienced staff. They consist of pure, stable cultures. Appropriate techniques are necessary to guarantee their viability, purity and stability as regards their genetic characteristics and to maintain them at appropriate temperatures. Infectious wild-type polio strains should not be used as controls.

## 3.6 **Laboratory safety**

Each laboratory should have available the *WHO Laboratory Biosafety Manual* (WHO/CDS/CSR/LYO/2003.4) available at: <http://www.who.int/csr/resources/publications/biosafety/Labbiosafety.pdf>.

This manual describes the essential biosafety, chemical, fire and electrical safety requirements to protect staff, the community and the environment. All staff should be familiar with the contents of this manual and should proceed accordingly. All new staff should be made aware of the risks involved in working in a polio laboratory before starting work in the laboratory and should be required to have

---

read the *Biosafety Manual*. The director is responsible for implementation of and compliance with the provisions of the manual.

When polio eradication is achieved, the laboratories will be the only remaining source of the virus. Safe handling and, ultimately, maximum containment of poliovirus and potential infectious materials in the laboratory is crucial. Wild poliovirus in the laboratory constitutes a special risk category that is of little or no risk to the immunized worker, but is a potential threat to successful eradication if transmission occurs in the community.

To ensure safe handling of wild polioviruses and potential infectious materials as eradication draws near, polio laboratories should follow the recommendations of the *Global Action Plan for Laboratory Containment of Wild Polioviruses* and institute BSL-2/polio biosafety levels.

The BSL-2/Polio biosafety level should include the following:

- Good microbiological techniques are practised (*Figure 3.4*).
- Facility meets standards for basic BSL-2 laboratory (*Figure 3.5*).
- Access to laboratory is restricted.
- Persons entering the laboratory have been fully immunized against polio.
- Sources of wild polioviruses are reduced or eliminated to reduce the risk of their inadvertent transmission:
  - Use of wild polioviruses is discontinued where attenuated vaccine polioviruses, inactivated antigens, or non-polio enteroviruses may serve the same purposes, for example as challenge viruses in neutralizing antibody tests.
  - All poliovirus stocks and potential infectious materials are disposed of when there are no programmatic or research needs for retention.
  - Laboratories no longer wishing to retain wild polioviruses should destroy all infectious and potential infectious materials by autoclaving or incineration.
- For laboratories retaining wild poliovirus materials additional requirements are:
  - Biosafety requirements are implemented that are appropriate to the activities being performed (BSL-2/polio or BSL-3/polio) or materials are transported to a laboratory that meets such biosafety requirements and where essential work can be safely conducted.
  - Only viruses that are readily identifiable by molecular methods are used if wild virus reference strains or working stocks are required.
  - All open manipulations with wild poliovirus infectious or potential infectious materials are performed using a certified class I or II BSC.
  - Wild polioviruses are stored in separate, secure areas with limited access.
  - Freezers and refrigerators are locked (with limited access to the key mechanism) and clearly marked as containing wild poliovirus materials.
  - Freezer inventories are current and complete, including nature of material, volume or amount, location in freezer.

- 
- Documentation is current on all stored materials, including geographical source and date of collection.
  - All materials are transferred to and from freezers in leak-proof, unbreakable, secondary containers.
  - SOP are established and regular training provided on responses to all spills, breakage of virus-containing vessels, and accidents where virus may have been released.

**Figure 3.4: Good microbiological techniques**

- Specimens are handled safely.
- No mouth pipetting is permitted.
- Pipettes and pipetting aids are used safely.
- Dispersal of infectious materials is avoided.
- Contact of infectious materials with skin and eyes is avoided.
- Ingestion of infectious materials is avoided.
- Separation of serum is carried out safely.
- Centrifuges are used safely.
- Homogenisers, shakers and sonicators are used safely.
- Tissue grinders are used safely.
- Refrigerators are maintained and used safely.
- Ampoules containing infectious materials are opened safely.
- Infectious materials are stored safely.
- Precautions are taken with blood and other bodily fluids.
- Specimens and infectious materials are shipped safely.
- Appropriate disinfection and sterilization are carried out.
- Gloves are worn for procedures that may involve direct contact with blood or infectious material.
- Hands are washed between procedures and prior to leaving laboratory.
- Laboratory gowns are worn for work in laboratory.
- Closed-toed shoes are worn for work in laboratory.
- Storage of food or drink in the laboratory or any storage receptacle containing infectious materials is prohibited.
- Eating, drinking, or smoking in the laboratory is prohibited.

---

**Figure 3.5: The Basic Biosafety Level 2 (BSL-2) facility**

- Ample space is provided for the safe conduct of laboratory work and for cleaning and maintenance.
- Walls, ceilings and floors are easily cleanable.
- Illumination is adequate for all activities.
- Storage space is adequate to hold supplies for immediate use.
- Hand washbasins, with running water, if possible, are provided in each laboratory room, preferably near the door.
- An autoclave (or suitable pressure cooker) is available in the same building as the laboratory.
- Facilities for storing outer garments and personal items for eating and drinking are provided outside the working areas.
- A good quality and dependable water supply is available. There are no cross-connections between sources of laboratory and drinking water supplies.
- A standby generator is desirable for the support of essential equipment such as incubators, biological safety cabinets, freezers, and the like.
- Pipetting aids are available to replace mouth pipetting.
- Biological safety cabinets are available for:
  - procedures with high potential for producing aerosols, including centrifugation, grinding, blending, vigorous shaking or mixing, sonic disruption, and opening of infectious materials whose internal pressure may be different from the ambient pressure;
  - handling high concentrations or large volumes of infectious materials.
- Centrifuges with sealed safety caps are available for centrifuging high concentrations or large volumes of infectious materials in the open laboratory. These caps must be loaded and unloaded in a biological safety cabinet.
- Screw-capped tubes and bottles are available to hold positive specimens and cultures.
- Autoclaves are available to sterilize contaminated material.

### 3.7 Audits

The objective of an audit is to carry out a systematic and independent examination to determine whether the quality activities and their results comply with the established documentation, and to confirm whether these activities are appropriate for achieving the desired objectives and whether they have been implemented effectively. Audits may be internal, performed by staff who do not have direct responsibility for the areas audited, or by the Laboratory Quality Assurance department. External audits are performed by the WHO annual accreditation of polio laboratories or by international bodies.

Audits may apply to:

- the whole quality system;
- some elements of the system (procedures, staff, equipment, working areas);
- processes;
- products;
- services.

---

Audits should not be confused with quality control activities. Laboratories should have a regular Internal Audit Programme.

Steps in an audit are:

- 1) review of documents;
- 2) drawing up of an audit plan;
- 3) opening meeting between auditor and the area to be audited;
- 4) rapid walk-through of the installation;
- 5) performance of the audit: interviews, checklist, and observation;
- 6) closing meeting;
- 7) audit report.

### ***3.7.1 Audit report***

The results of the audit are compiled into a report that indicates the date the audit was performed and contains a description of the observations, deviations or instances of nonconformity, and the recommendations or corrective measures suggested. This report is sent to the director of the area audited and to the executive director who shall be responsible for ensuring compliance with the resulting recommendations.

### ***3.7.2 Follow-up audit***

If nonconformity is encountered, follow-up audits are performed to verify the implementation of corrective actions.

---

## 4. Cell culture techniques

The quality of cell cultures used in the virological investigation of poliomyelitis is important for the standardization of poliovirus isolation and its characterization. This chapter provides some guidance on the correct handling of cell cultures used for virus diagnostic procedures.

### 4.1 Working in the cell culture laboratory

Maintenance of trouble-free cell cultures depends on careful attention to culture conditions and passage procedures. It is also vital to pay strict attention to three characteristics that are fundamental to the quality of cell culture assays: purity, authenticity and stability.

**Purity:** Contamination with microorganisms such as bacteria and fungi will normally kill the cells and put other cultures in the laboratory at risk. Mycoplasma contamination can have serious effects on a cell culture (*see below*) without inhibiting cell growth and, furthermore, the presence of such contamination will rarely be apparent even under microscopic observation. This is due to the extremely small size of mycoplasma organisms that can enable them to pass through sub-micron filters. As with bacteria and fungi, mycoplasma can spread readily to other cultures but are not susceptible to many of the antibiotics effective against bacterial contamination. While viral contamination typically produces a cytopathic effect in cell cultures, persistent non-cytopathic infections may arise that can influence virological investigations and may represent a hazard to laboratory workers (e.g. Epstein Barr Virus expressed by B95-8 and B95a cells). Screening for viral contamination can be extremely costly and time consuming. Routine checks for bacteria, fungi and mycoplasma, however, are relatively easy to establish and will provide confidence in the quality of cell culture results.

**Authenticity:** Accidental switching of cell lines or cross-contamination between cultures has been identified in numerous cases and can result in erroneous or misleading data. Obtaining documentary evidence for the authenticity of new cell lines and identity testing are therefore important means of avoiding wasted time and effort. All cell lines used in the polio eradication initiative should be obtained through the Global Polio Laboratory Network. To avoid cross-contamination only one cell line should be handled at a time in a cabinet, and between culture sessions the work area should be stringently cleaned and disinfected.



---

**Stability:** Cell cultures serially passaged over an extended period of time will invariably show some signs of variation in genetic or phenotypic characteristics. The susceptibility to such variation will differ between cell lines. To minimize the effects of cell line deterioration it is strongly recommended that all cell lines used routinely for polio isolation be replaced after a maximum of 15 sequential passages.

#### *4.1.1. Basic requirements for cell culture*

Although the cost of laboratory space and equipment necessary for the handling of cell cultures in a diagnostic virology laboratory can be reduced to relatively modest levels, certain essential items are required. Due to the difficulty of cleaning and recycling glassware to cell culture quality, many laboratories have resorted to using disposable cell culture plasticware. It is recommended that all laboratories use cell culture plastic-ware for as many processes as possible. The standard list of items for cell culture is displayed in Table 4.1.

#### *4.1.2 Laboratory layout and operation*

Cell culture should be performed in an environment that is tidy and not crowded or otherwise busy. Environmental contamination should be kept to a minimum through good housekeeping and cleaning regimes and some provision should be made for the isolation of untested and contaminated cultures. The important principles and approaches that may be adopted to ensure satisfactory operation of a cell culture laboratory include:

- Only essential personnel should have access to cell culture areas.
- Cell culture areas should be dedicated for this purpose and separate laboratories or areas established for other work.
- Each cell culture work station should be organized such that all items needed are readily to hand, avoiding the necessity to withdraw from the safety cabinet while handling cells.
- Laboratory layouts should allow for easy movement of personnel between the safety cabinet and fridges, centrifuges, incubators, etc.
- The use of sinks in the cell culture area should be avoided since these can be a source of microbial contamination.
- For safety reasons liquid nitrogen storage areas should be well ventilated.
- Standard operating procedures should be established for:
  - waste disinfection and disposal;
  - procedures for disinfecting equipment such as centrifuges and BSCs;
  - water bath cleaning/disinfection;
  - cleaning of work surfaces and floors;
  - periodic thorough cleaning to prevent build-up of contamination and dust (e.g. on high flat surfaces, outside of BSCs, underneath and behind equipment, inside fridges and freezers).

---

**Table 4.1: Essential items for cell culture**

Item	Number
Autoclave, large, or bench top for small lab	1
Balance, electronic with power adaptor	1
Cabinet, class II biosafety	1
Centrifuge, low speed, refrigerated	1
Counting chambers	2
Pipettes, sterile, 1 ml	1000
Pipettes, sterile, 10 ml	1000
Pipettes, sterile, 25 ml	500
Pipette-aid	1
Flask, sterile, 25 cm <sup>2</sup>	100
Cell culture tubes, 16 x 125 mm	10 000
Cryovials, 2 ml and 4 ml	1000
Flat bottom TC quality, sterile microtitre plates	500
Freezer, -20° C, household, non-frost free, chest type	1
Incubator, standard	1
Liquid nitrogen container, 25–20 litres for reserve nitrogen	1
Liquid nitrogen storage system	1
Media filtration system, autoclavable, and accessories	2
Meter, pH, hand held with spare electrodes	1
Microscope, inverted	1
Microscope, standard	1
Mixer, vortex	1
Oven, hot air sterilizing	1
Refrigerator, household 4°C	1
Stirrer, heated, magnetic with stirrer bars	1
Storage system for chest freezer	1
Test tube rack for 16 mm tubes	6
Water distiller, double or triple, glass	1
Water deionizer (cartridge)	1

- 
- Equipment files should be prepared to store validation, installation and maintenance records.
  - Laboratory supervision can be assured by appointing a key member of staff in each laboratory with responsibility for maintaining equipment and safety records.

#### ***4.1.3 Use of equipment***

For successful and reliable isolation of viruses in cell culture it is vital that equipment used for manipulation and cultivation of cells is calibrated and monitored appropriately. Each laboratory should maintain a file for each piece of equipment that identifies calibration and maintenance requirements and holds records of these procedures and routine data recording. Small laboratory equipment (pipettes, pipettors etc.) should be dedicated for cell culture activities and should not be shared with laboratories handling microorganisms.

**Biological safety cabinets:** Most cell culture handling is now carried out in Class II Biological safety cabinets. These cabinets maintain a clean working environment for cell handling and help to provide protection to the operator and environment. Horizontal laminar flow cabinets are useful for media preparation but are not desirable for cell culture work due to the risk of possible contaminants in the cell culture being blown into the face of the operator. The effectiveness of a BSC is dependent on its position, correct use, regular testing and maintenance. An example of good practice for all of these aspects is given in the British Standard BS5726 (accessible for a fee at the web site <http://bsonline.techindex.co.uk/>).

Cabinets should be sited away from doors and through-traffic. Movement in the area of a BSC will disturb airflow and so access to the area should be restricted to essential personnel. When working within a BSC it is important to minimize the potential for contamination of the working environment and cross-contamination between cell lines. This can be greatly assisted by the following:

- Switch cabinets on 10–20 minutes before use and leave them on afterwards for a similar period.
- Do not make rapid movements within the cabinet as this disrupts airflow.
- Manipulate fluids slowly and gently to avoid creating aerosols.
- Never have more than one cell line in a cabinet at the same time.
- Do not overcrowd the cabinet and never obstruct the front opening.
- Organise the work area so that sterile reagents and cultures do not come into contact with each other (e.g. pots for liquid waste to the left and sterile media to the right with cultures handled centrally).
- Do not place recording sheets, log books or other documents in or on the BSC, as they may interrupt the air flow, become contaminated with infectious organisms and cannot be properly disinfected.

**Figure 4.1: The Class II, biological safety cabinet**

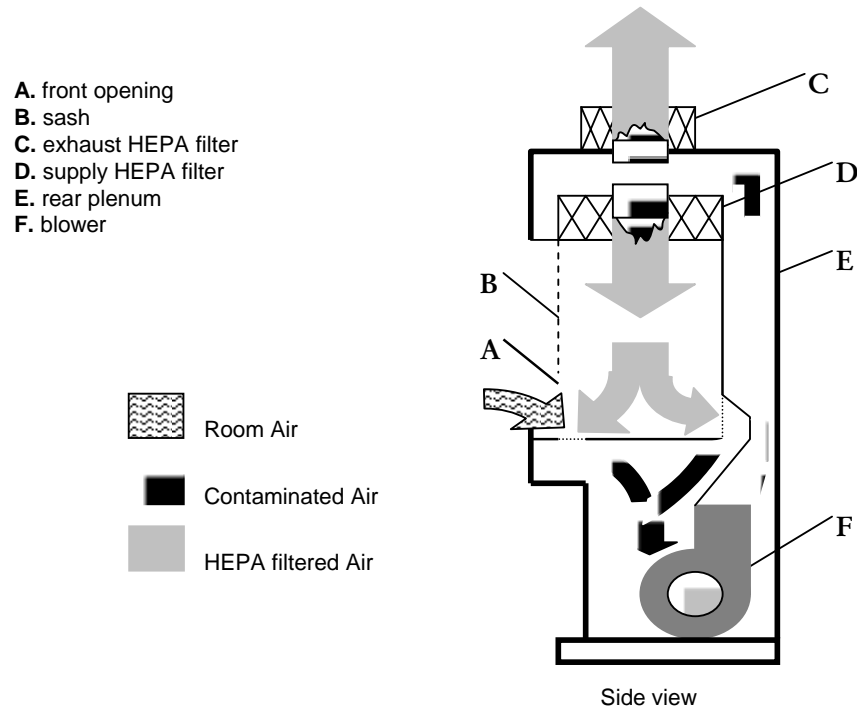

- Periodically test cabinets for:
  - filter integrity (e.g. oil mist test) and operator protection (e.g. potassium iodide release test);
  - air flow;
  - containment (these tests are described in BS2756 and should be repeated by experienced personnel when the cabinet is moved or the laboratory layout altered).
- Clean and decontaminate the cabinet inner surfaces (both horizontal and vertical) after every working session and periodically (e.g. once per month) decontaminate the tray under the BSC working surface.
- Replace the BSC front cover when not in use to prevent entry of dust and aerosols.
- **Do not use a Bunsen or similar burner inside a BSC (unless absolutely required for a specialized procedure) as they disrupt the airflow pattern, can damage the HEPA filters and pose a fire risk.**

---

**Incubators:** There are two classes of incubators, standard and carbon dioxide (CO<sub>2</sub>). The following steps should be taken concerning the correct use of incubators:

- New incubators should be installed, calibrated and maintained according to the manufacturer's instructions. Refer to Section 3.4 of the *Polio Laboratory Manual* concerning laboratory equipment.
- Refer to Section 4.3 of the *Polio Laboratory Manual* for a description of the types of media recommended for growing cell cultures in each class of incubator.
- Incubators designated for cell culture must **not** be used for incubating microorganisms or biochemical specimens.
- The incubator temperature should be set to 36°C.
- An independent traceable thermometer should be set inside the incubator chamber and monitored every day by the first person to open the chamber door. A record of the readings needs to be maintained and archived.
- Every two to three months the incubator should be emptied and all shelves pulled out. Everything, including the shelves, walls, top and bottom, should be cleaned thoroughly with either a disinfectant or 10% bleach solution, then rinsed thoroughly with clean distilled water to remove residues that can cause corrosion and toxicity to cell culture, then dried and put back in place.
- All spills must be contained and disinfected immediately.
- In addition to the thorough cleaning listed above, it is recommended to wipe shelves with 70% ethanol solution weekly.

**Standard incubators (non-CO<sub>2</sub>):** These incubators are simple, effective and usually very reliable but require all cell culture vessels to be well sealed in order to maintain proper pH for cell culture (between 7.2 and 7.4) as well as prevent evaporation of the culture medium.

All cell culture flasks, tubes or plates in a non-CO<sub>2</sub> incubator must be well sealed. Close the lids of flasks or tubes securely. Seal the lids of microtitre plates with non-toxic sealing tape or place them in a sealed plastic box with moistened paper in the bottom. This helps to reduce the risk of cross-contamination with other cultures.

**CO<sub>2</sub> incubators:** These incubators provide humidity and a 5% CO<sub>2</sub> atmosphere for cell culture. In addition to the steps listed in the general information above, the following should be considered:

- A constant and reliable supply of clean, high quality CO<sub>2</sub> is required.
- To allow proper exchange of the humid 5% CO<sub>2</sub> atmosphere with the medium, cell culture flasks, tubes and plates should not be sealed, but culture vessels with “vented” caps should be used.
- CO<sub>2</sub> levels should be checked and recorded three to four times a year using a Fyrite apparatus (or equivalent) as internal calibrations often drift over time.
- A water tray placed in the incubator supplies the humidified environment.

- 
- Every week the water tray needs to be emptied, wiped with 70% ethanol and refilled with autoclaved distilled water to prevent bacterial and fungal contamination. Alternatively, antibacterial/antifungal agents as recommended by the manufacturer may be added to the water, but many chemicals can be toxic to cells, corrosive, and dangerous to humans.
  - In addition to the cleaning procedures listed above, special care must be taken in humid chambers to check the water tray and chamber daily. Wipe all condensation from the shelves and bottom of the incubator as well as all the gaskets to prevent fungus, mould and mildew from becoming established.
  - Temperature, CO<sub>2</sub> and relative humidity readings should be taken daily and a record of the readings maintained and archived.

**Water-purifying apparatus:** The use of high purity, toxin-free, water (type I water) is essential for successful cell culture. Glass distillation or other water purification techniques (e.g. deionization) may be used but the water for cell culture should be autoclaved before use. One of the best sources of water for preparing cell culture media is pharmaceutical grade water for injection. All water for cell culture should be used as soon as possible after collection, as storage in any container will allow degradation of the purity of the water unless both the water and container are sterilized.

**Double glass distillation:** This was the first system to be used widely for cell culture and is still effective. The still should be electric and the first still should automatically feed the second still. Distillation has the advantage that the water is heat-sterilized and of high purity but disadvantages include the large volume of water required for the distillation processes, slow production rate, high cost of operation and requirement for constant maintenance.

**Deionization:** Deionization requires a multistage process where the feed water is purified step-wise. The first step is usually reverse osmosis and subsequent steps can remove organic or inorganic materials (activated carbon) with further purifying steps (deionization) which may include membrane filtration depending on the quality of the feed water. The quality of the final product can be monitored using a conductance meter, which ideally should be around 18 megohm/cm. Advantages of the deioniser system are the high throughput of pure water, low wastage of water and the fact that the system can be modified according to the quality of the feed water.

#### ***4.1.4 Preparation of sterile media and reagents***

To ensure sterility of equipment and reagents it is recommended to use an autoclave to sterilize all components and reagents that are heat-stable. An autoclave cycle that ensures a sterilizing temperature of 121°C for at least 15 minutes at a pressure of 15 psi (100 kPa) is adequate for liquid reagents, whereas for equipment sealed in autoclave bags a temperature of 126°C is desirable, or 121°C for 20 minutes. Autoclaves should be allowed to cool to 80°C before opening and, once removed, sterilized media should be left in a clean and safe area to cool. Ideally autoclaves should be calibrated annually to ensure the appropriate temperature and pressure profiles are achieved during the autoclave cycle. Many brands of autoclave tape

---

activate at 100°C and therefore should not be relied upon to be a fail-safe indicator of sterilization at 121°C, but spore strips may be used for this purpose. The latter are taken from the autoclave and incubated in bacteriological broth media in parallel with an untreated (viable) strip. As with all critical equipment, autoclaves should be systematically validated.

Heat-labile reagents will normally be filter-sterilized (0.22 µm pore-size), for which good aseptic technique is required and which may be assisted by the use of laminar flow cabinet or disinfected BSC for sterile transfers of media to sterile storage containers. Some reagents, such as glucose solutions, may have some degree of heat resistance and may be sterilized in an autoclave at 115°C, 10 psi (70 kPa) for 15 minutes.

For all prepared media batch preparation details should be recorded (including details of the raw materials used) and an expiry date assigned to each batch. Wherever practicable the reagent name, batch number and expiry date should be clearly marked on each aliquot of the batch. Prepared medium should be stored away from sunlight to prevent the formation of cell toxic components.

#### ***4.1.5 Sterility testing***

Filtration: When filtration is complete the filter should be “bubble point” tested, where the pressure of the pump is increased at the end of the filtration and, if the membrane is intact, then air should not pass through the 0.22 µm pore size membrane below 75 psi (500 kPa). If the membrane passes the bubble test then aliquots of media should be taken from the beginning, middle and end of the run and incubated at 36°C for 72 hours. Any aliquots showing cloudiness should be discarded and the whole batch re-sterilized. If any media in the stored containers show cloudiness then the whole batch should be discarded. For a more thorough test, take representative samples of the filtered batch and dilute one third of each into nutrient broths e.g. beef heart infusion and thioglycolate. Divide each into two, and incubate one at 20°C and the other at 36.5°C for 10 days with uninoculated controls. For example, remove 10 ml of filtered medium, add 5 ml of media to 10 ml of nutrient broth and remaining 5 ml to 10 ml of thioglycolate, divide both into two and incubate at the two temperatures. If any show signs of cloudiness treat as above.

Sterility checking of autoclaved stocks is much less essential, provided proper monitoring of temperature and time of sterilization is carried out.

All media should be visually checked before use for correct pH, colour, and signs of contamination, no matter how it has been sterilized. If a bottle of media has been standing for a long period, low-grade contamination may form a fine sediment on the bottom of the bottle. If gentle swirling shows a spiral of sediment rising from the bottom then the media in the bottle may be contaminated and should be discarded.

---

## 4.2 Cell culture procedures

The following important conditions must be satisfied to achieve successful cell culture:

- Incubation temperature should be 36°C.
- The pH for growth should be between 7.2 and 7.4.

The levels of glucose and L-glutamine can influence cell growth, and correct levels for each cell line should be checked before attempting to put it into culture (typical levels for glucose and L-glutamine are 1–4 mM and 2 mM, respectively). A range of inorganic ions, amino acids and vitamins are essential for cell survival and will usually be included in basal growth media from proprietary sources. Both oxygen and carbon dioxide are essential and are provided either as a mixture of CO<sub>2</sub> and air supplied to the culture vessel or by sealing the vessel tightly to retain the CO<sub>2</sub> produced by cell metabolism.

### 4.2.1 Aseptic technique

Skill in aseptic technique is important to maintain sterility during media preparation and cell cultivation procedures. Furthermore, it is a vital component in ensuring operator protection from infectious agents that may be present in culture materials. Some important elements in aseptic technique are:

- Sterilize all glassware for handling cell cultures and media (*see below*).
- Avoid splashes, spills and aerosols.
- Avoid liquid transfer by pouring.
- When adding (or replacing) medium, never touch the neck of the culture flasks with the bottle containing the medium or use the same pipette to transfer medium to more than one bottle. Ideally, aliquot the total amount of medium required for each batch of culture bottles being handled and store the remainder at 4–8°C. Dedicate separate medium for each cell line.
- Separate clean and contaminated materials in the BSC II.
- Minimize exposure of sterile media and cell cultures to open air (even within the BSC II).
- Perform any final preparation of sterile media (i.e. addition of serum or other additives) before dealing with cell cultures.

Because of the risks of contamination and cross-infection, cell culture in the virus diagnostic laboratory is best carried out in closed vessels, usually screw-capped tubes and flat-sided bottles. **WHO does not recommend the use of 24-well plates for the isolation of polioviruses from stool specimens** as this method is inappropriate to conditions encountered in many laboratories of the Global Polio Laboratory Network. Cultures are initially set up in growth medium supplemented with 10% serum. Once the cells have formed a confluent monolayer, cultures are changed to maintenance medium which is designed to maintain cultures in a healthy state for as long as possible without stimulating growth; this is achieved by reducing the serum content, usually to 2%.



---

#### 4.2.2 Preparation of glassware

Due to the difficulty of cleaning and recycling glassware to culture quality, many laboratories have resorted to using disposable cell culture plasticware. If a laboratory chooses to use glassware, however, it must ensure that all glassware is meticulously cleaned and sterilized so that cell cultures will not be affected by traces of proteinaceous material, detergent, pyrogens, water deposits and other residual materials which may get deposited on the glassware.

Glassware cleaning protocols should be developed along the lines of the following procedures:

- Use care in handling glassware as most breakages occur during the cleaning process.
- Before cleaning, decontaminate glassware by autoclaving or soaking overnight in chlorine solution (0.5%).
- Decontaminate pipettes in a container containing chlorine.
- Rinse all glassware as soon as possible after use.
- Store soiled items in water containing a disinfectant or cleanser to avoid drying and making items harder to clean.
- Use 7-X, DECON or similar detergent for thorough cleaning of all laboratory glassware. These detergents are easily rinsed from glassware without leaving residues. (**DO NOT use domestic dishwashing liquid detergent under any circumstances.**)
- Clean glass by scrubbing with a brush. Periodically inspect brushes for wear to avoid scratching glass.
- Thoroughly rinse items in tap water, followed by at least 5–7 changes of distilled or deionized water. Even the smallest residual amounts of cleansers, disinfectants or acids can affect the growth of cell cultures.
- Dry glassware on racks or peg boards and inspect after drying. If glassware is hazy, has a film or blotches are evident, then additional cleaning is required before use.
- Sterilize cell culture glassware using a hot air oven at 180°C for three hours to destroy pyrogens. Non-glass components which may not withstand 180°C should be sterilized by alternate methods such as autoclaving, and re-assembled aseptically.

**Chromic acid wash:** Some heavily soiled glassware may require vigorous methods to clean and traditionally this has required the use of chromic acid (10% potassium dichromate in 25% sulfuric acid). Chromic acid, however, is a hazardous substance, with safety and environmental concerns. There are effective commercially available substitutes to chromic acid which include: Fisher product, **Contrad 70** or VWR Scientific products, **Chem-Solv**, phosphate-free formulations of **RBS-35**, **PCC-54** and **Nochromix** (also supplied by Fisher).

---

If chromic acid must be used, follow all normal safety precautions for using concentrated acids and acid solutions. As with any other cleaning process, all cleaning solutions must be completely rinsed from the glassware through copious changes of tap water followed by several changes of distilled water.

#### 4.2.3 Selection of cell culture systems

Many cell culture systems support the growth of polioviruses and other enteroviruses.

**WHO recommends** that all specimens suspected of containing polioviruses be inoculated into the following two cell lines: L20B cells, a genetically engineered mouse cell line expressing the human poliovirus receptor; and RD cells, derived from a human rhabdomyosarcoma. The selection of only two cell lines for the laboratory diagnosis of poliomyelitis permits the standardization of techniques and the comparability of results among various virus laboratories, while providing high sensitivity for poliovirus detection.

Regional reference laboratories (RRL) are advised to obtain cell cultures from the official collections. Requests for these cell lines should be submitted to IVB/VAM, WHO, Geneva.

National poliomyelitis laboratories can in turn apply to their designated RRL for supplies of these cell lines. As soon as possible after the receipt of cell cultures, a cell bank should be established in liquid nitrogen, or if this is not available, in a mechanical freezer at  $-70^{\circ}\text{C}$  or lower. Cells stored at  $-70^{\circ}\text{C}$  will not remain viable for very long periods and aliquots should be resuscitated every 4–6 months, passaged to build up numbers, and stored again at  $-70^{\circ}\text{C}$ .

#### 4.2.4 Preparation of cell culture systems

Cells should be received with documented evidence for the key characteristics relating to the quality of cell cultures as described above. In handling cell cultures, laboratory personnel must be concerned not only with preventing microbial contamination of the cultures, but also with avoiding contamination of the working environment with cell culture materials. All cultures must be considered potentially hazardous, whether inoculated or uninoculated. After use all cultures and their fluids should be decontaminated by autoclaving. Cross-contamination between different cell types, especially continuous cell lines, is an ever-present hazard. To avoid this, *different cell lines should never be processed at the same time*. All working areas should be thoroughly cleaned between the preparation of different cell types.

Cell culture media employed in virology can be divided into two main categories, growth media and maintenance media.

**Growth media (GM)**, high in serum content (usually 10%), promote rapid cell growth. After a monolayer has formed and prior to inoculation with virus, the growth medium is removed and replaced with maintenance medium.

---

**Maintenance media (MM)**, low in serum content (usually 2%), are intended to keep the cell cultures in a steady state of slow cell replication whilst maintaining cell metabolism during the period of viral replication.

**Fetal calf serum is the serum of choice:** it is good for promoting cell growth and it lacks viral inhibitors. If serum from other sources is used, it must be pre-tested for the presence of inhibitors to the viruses being studied. All sera for cell culture use must be inactivated at 56°C for 30 minutes.

#### *4.2.5 Passaging a cell culture*

##### *(i) Maintenance of L20B and RD cell cultures*

See Section 4.3 for details on preparation of key reagents. Have available the following items:

- Culture flasks with confluent monolayers of L20B or RD cells (NB: cultures that have been confluent for longer than two weeks should not be used);
- Phosphate buffered saline (PBS) without calcium and magnesium;
- Trypsin (or trypsin/Versene);
- Growth medium;
- Trypan blue (if cells are counted);
- Cell counting chamber;
- Cell culture tubes and flasks;
- Pipettes.

Good laboratory practice: Work with one cell line at a time.

##### *(ii) Procedure*

- Examine the cells for quality (i.e. an entire monolayer of healthy cells) and absence of contamination as determined by visual examination.
- Decant growth medium from the cell culture flask and gently wash the confluent cell layer twice with Ca and Mg free PBS.
- Add 0.25% trypsin solution (or equal parts of 0.25% trypsin and 1:5000 Versene solution) in PBS to the monolayer, dispersing it evenly. (A volume of 0.5 ml is adequate for a 25 cm<sup>2</sup> flask.)
- Place the flask in a 36°C incubator until the cells detach from the surface: this may be assisted by tapping the side of the flask a few times. Check for complete detachment of cells by examining under an inverted microscope.
- Re-suspend the cells in growth medium (4.5 ml to a 25 cm<sup>2</sup> flask), which halts the action of the trypsin. Gently aspirate the suspension a few times through a fine Pasteur pipette to break up cell clumps.

- Dilute with growth medium to the desired concentration based either upon counting the cells (*see below*) or upon a pre-determined split ratio (usually 1:3 or greater). The optimum split ratio (determined by cell counting) required to obtain confluent monolayers of cells in appropriate time must be determined for each new batch of cells received in the laboratory and whenever there are changes to major media components (e.g. fetal calf serum, MEM). The split ratio will quickly become apparent as experience is gained with each culture.
- Seed fresh culture flasks or tubes, cap tightly, and place in a 36°C incubator.
- Change tubes to maintenance medium when the monolayer is nearly confluent (2–3 days). Flasks are usually subcultured every 5–7 days, at a split ratio determined by experience.

**Table 4.2: Approximate volumes and seeding levels for L20B and RD cell culture**

Cell culture vessel	Approximate volume	Seeding level (total cells)
125 x 16 mm tube	1 ml	$1 \times 10^5$
25 cm <sup>2</sup> flask	10 ml	$1 \times 10^6$
75 cm <sup>2</sup> flask	25 ml	$2.5 \times 10^6$
150 cm <sup>2</sup> flask	50 ml	$5 \times 10^6$

**Good laboratory practice:** The seeding levels for various culture vessels are provided as a guide. The optimum seeding level may differ according to cell line, batch of cells, and with changes in media components. Cell counting should therefore be used to determine the appropriate seeding density or split ratio for new batches of cells or whenever there are changes in major media components. Cell counting should also be used when preparing cell culture tubes for virus isolation to ensure that cell monolayers last for 5–7 days and that there is reproducibility between batches of prepared cells.

*(iii) Alternative procedure*

- Decant growth medium (GM) from the cell culture flask and gently wash the confluent cell layer with PBS (without the calcium and magnesium components).
- Add 0.25% trypsin solution (or equal parts of 0.25% trypsin and 1:5000 Versene solution) in PBS, sufficient to cover the cell monolayer.
- Incubate at 36°C until all the cells detach from the flask (check with inverted microscope).
- Centrifuge the cell suspension at 100 g for 10 minutes and remove the supernatant.
- Resuspend cell pellet in GM to desired concentration based either upon counting the cells (use Trypan blue to determine ratio of viable to non-viable cells) or use a 1: 2 to 1: 8 “split” and seed fresh culture vessels/tubes. Change tubes to maintenance medium (MM) when nearly confluent (2-3 days). Flasks are usually subcultured every 4–7 days, a 1: 6 to 1: 8 “split” being typical.

**Good laboratory practice:** Keep a careful record of all the passages carried out after receipt of original RD and L20B cell lines. Label each culture flask with cell type, passage number and dates of seeding bottle and any medium changes. If the same cell line has been received from more than one source or at different times it is important to be able to differentiate these cultures from each other in case one is later found to be inappropriate for use.

*(iv) Cell counting*

Accurate numbers in a cell suspension can be calculated by counting the cells in a haemocytometer (e.g. improved Neubauer); it is important to disperse the cells thoroughly by pipetting up and down. A typical method for enumerating cell concentration using “improved Neubauer” haemocytometers is given below.

- 1) Dilute 0.2 ml of the cell suspension in 0.2 ml of trypan blue (N.B. use 0.1% w/v trypan blue in PBS solution); non-viable cells are stained blue.
- 2) Immediately mix well with a fine Pasteur pipette and aspirate sufficient volume to fill both sides of the haemocytometer chamber.
- 3) Count viable cells in each of the four corner squares bordered by triple lines, omitting cells lying on these lines (*see Figure 4.2*). This is repeated for the second side of the chamber. N.B. cell counts of less than fifty cells are unlikely to be reliable.
- 4) If a marked degree of cell “clumping” (aggregation) is observed, discard and re-suspend the original cell suspension.
- 5) Calculate the mean count of the total viable cells per four corner squares (N.B. viable cells are not stained by Trypan blue).
- 6) Count and calculate the mean count of the other half of the counting chamber. For a valid test, the results of the two counts should be within 20% of the mean value.
- 7) Calculate the viable cell concentration per ml using the following formula:

$$C_1 = t \times tb \times 1/4 \times 10^4$$

t = total viable cell count of four corner squares

tb = correction for the trypan blue dilution (counting dilution was 1/tb)

1/4 = correction to give mean cells per corner square

$10^4$  = conversion factor for counting chamber

$C_1$  = initial cell concentration per ml

**Example:** t = 480; tb = 2;  $C_1 = 480 \times 2 \times 1/4 \times 10^4 = 2.4 \times 10^6$  cells per ml

- 8) Calculate the dilution factor (d) to obtain the working cell concentration per ml ( $C_2$ ).

$$d = C_2 \text{ (working cell concentration)} / C_1 \text{ (initial cell concentration)}$$

**Example:**  $C_1 = 2.4 \times 10^6$

$$C_2 = 2 \times 10^5$$

Then:  $d = C_2/C_1 = (2 \times 10^5) / (2.4 \times 10^6) = 2/24 = 1/12$

Figure 4.2: Cell counting using a haemocytometer (based on Freshney)

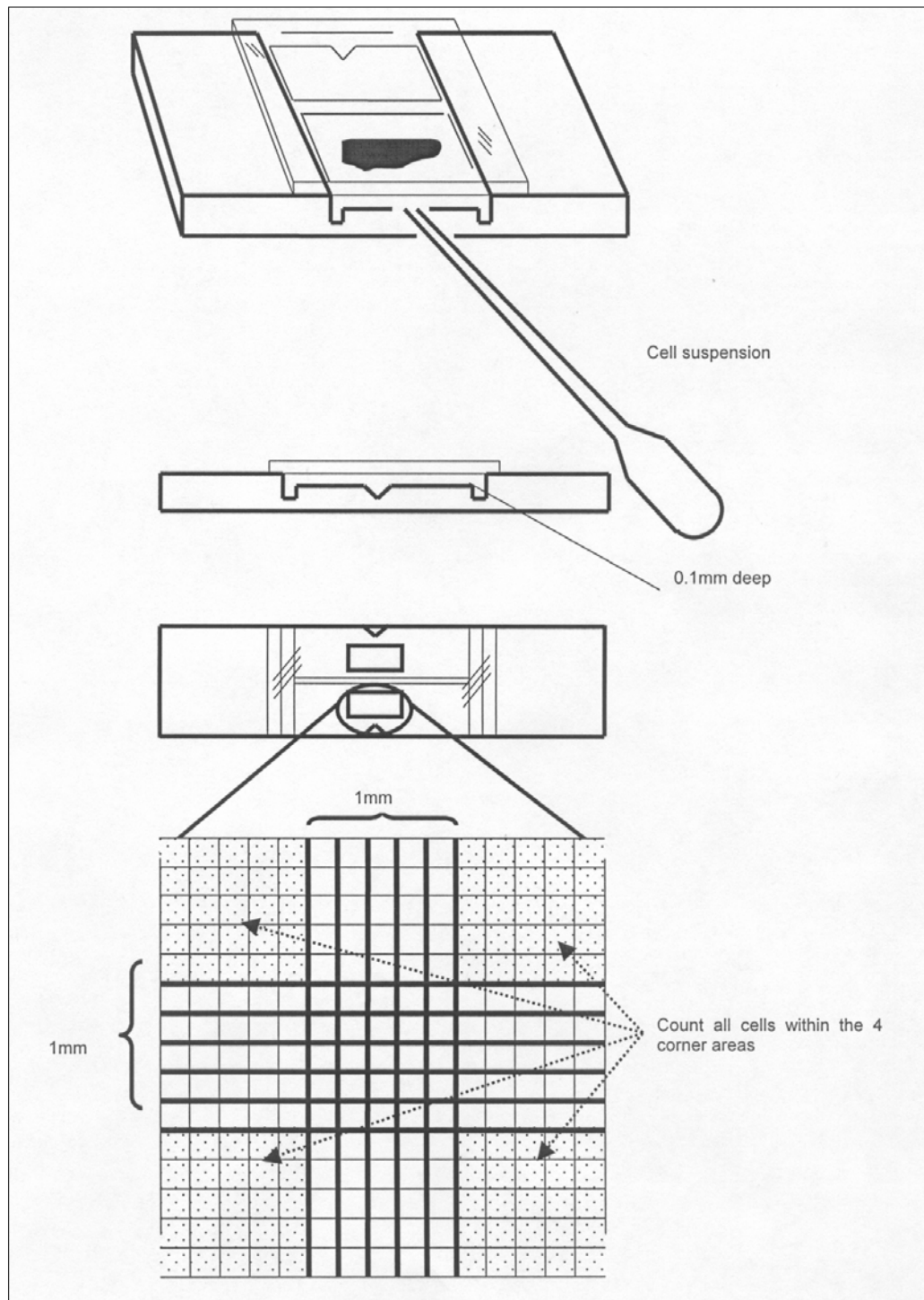

---

The working concentration can be obtained by mixing 1 volume of the original cell suspension with 11 volumes of the growth medium.

- 9) Dispense the cells in growth medium, seed into flasks/tubes and incubate at 36°C. Most continuous cell lines should form confluent monolayers within a few days.

**Important note:** The example given above is only correct for counting chambers of the “improved Neubauer” type. Other counting chambers such as Bürker-Türk may have other specifications.

Important variables in these counting chambers are:

- a) the depth of the chamber. In the example above this is 0.1 mm; in some counting chamber types, however, this is 0.2 mm.
- b) the number of smallest squares per cm<sup>2</sup>. In the example above, there are 25 squares per cm<sup>2</sup>, each 0.2 mm long and 0.2 mm wide; in some counting chambers, however, there are 16 squares per cm<sup>2</sup>, each 0.25 mm long and 0.25 mm wide.

When counting chambers with different specifications are used, different algorithms have to be followed for the correct calculation of the number of cells per ml. **It is important to check the specifications of the counting chamber in use and follow the calculation instructions that go with individual counting chambers.**

#### *(v) Preservation of cell cultures*

It is possible to maintain stocks of cells in a viable state for long periods at low temperatures by the addition of a cryoprotectant such as dimethyl sulfoxide (DMSO) to the cell growth medium. The essential features of the method are to *freeze the cells slowly (i.e. at approximately -1°C/min)*, keep them at a temperature below -70°C while frozen and to *thaw them rapidly* ready for the preparation of fresh cell culture stocks. Long-term storage can only be achieved reliably when cells are stored at or below -135°C.

**DMSO** is a powerful solvent that potentiates absorption and will carry any compound or material (toxic or benign) with which it comes into contact through the skin and into the body. At all times care should be taken to avoid DMSO coming into contact with the skin.

---

#### 4.2.6 Freezing cells

- 1) Use only cultures of cells that are in a healthy state (i.e. rapidly growing but not completely confluent).
- 2) Detach cells with Trypsin (or Trypsin/Versene — see Section 4.2.4). Use sufficient flasks to yield a minimum of  $4 \times 10^6$  cells/ml in the final cryoprotectant solution.
- 3) Re-suspend cells in growth medium; centrifuge at  $100 \times g$  for 10 minutes.
- 4) Discard the supernatant and re-suspend thoroughly the cell pellet in pre-chilled growth medium containing 20% fetal calf serum and 10% (v/v) dimethyl sulfoxide.
- 5) Dilute 0.1 ml cell suspension in trypan blue and count cells in a haemocytometer as described in Section 4.2.5.
- 6) Adjust cell concentration to  $4-8 \times 10^6$  cells/ml (if large flasks will be used for cell revival) or  $2 \times 10^6$  cells/ml (if small flasks will be used for cell revival) in growth medium containing DMSO.
- 7) Dispense in 1 ml or 2 ml volumes in clearly labelled (cell name, laboratory of origin, passage number and date of freezing) screw-capped, external thread vials (caps should be tightly closed), or polypropylene-sealed/glass-sealed ampoules. The former are suitable for storage in gaseous nitrogen, the latter for storage in liquid nitrogen.
- 8) Freeze vials/ampoules slowly. Ideally the temperature should drop at  $1^\circ\text{C}/\text{minute}$ . Place vials/ampoules in the special container that holds them in the gaseous phase of the liquid nitrogen vessel. Commercial devices are available for which a formula is supplied by the manufacturer for the level vials/ampoules are held, number to be stored and length of time required to achieve this temperature drop (see Figure 4.3). Alternatively, place vials/ampoules wrapped in paper towels or cotton wool in a polystyrene container with a wall thickness of  $\sim 25$  mm and place this in the  $-70^\circ\text{C}$  freezer overnight.
- 9) Transfer the vials to the gaseous phase ( $-150^\circ\text{C}$  to  $-180^\circ\text{C}$ ) and polypropylene or glass-sealed ampoules to the liquid nitrogen ( $-196^\circ\text{C}$ ) storage containers (see Figure 4.4). For long-term storage of cells (i.e. a period of years) liquid nitrogen storage is more reliable.

**Good laboratory practice:** When using gaseous phase or liquid nitrogen containers, closed-toed shoes, visors and heavy-duty gloves must be worn to avoid injuries from nitrogen splashes or explosion of imperfectly-sealed ampoules.



**Figure 4.3: Apparatus for controlled cooling of cells (after Freshney)**

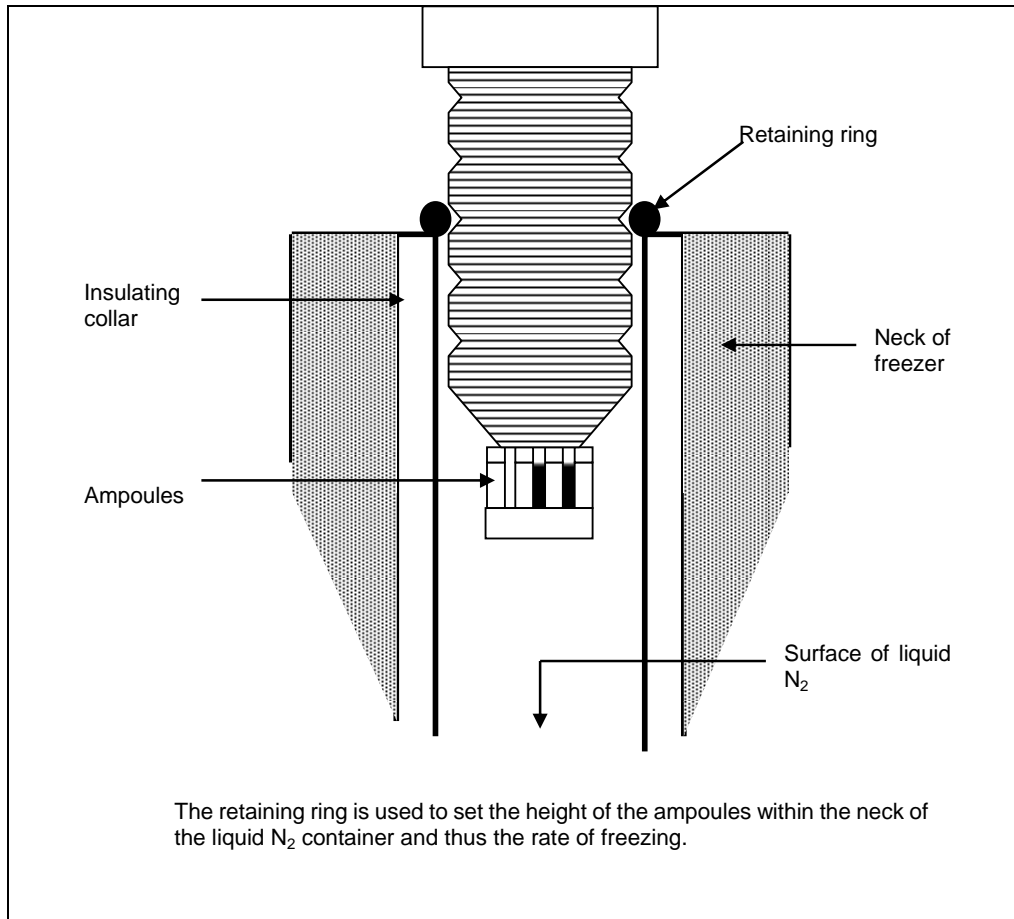

#### 4.2.7 *Thawing cells*

Remove vial/ampoule from gaseous/liquid nitrogen and transfer immediately to a water bath or preferably a beaker of sterile water at 36°C.

When contents are completely thawed, wipe outside of vial/ampoule with alcohol to reduce bacterial contamination, transfer cell suspension to culture flask. Add, drop-wise, sufficient growth medium for the production of a cell monolayer (N.B. If storage vials contain cells at a concentration of  $4 \times 10^6$  cells/ml, then 1 ml cell suspension should be sufficient for one or two 75 cm<sup>2</sup> flasks). The viability of the thawed cells may be significantly reduced if growth medium is added rapidly at this delicate stage.

Incubate flask until cells are adherent (6–8 hours) or overnight at 36°C. Carefully decant medium (to get rid of DMSO present) and add fresh growth medium.

As an alternative to the above procedure spin thawed cell suspension (made up to 10 ml slowly with growth medium) at 80 x g for 10 minutes; discard supernatant and re-suspend cell pellet in sufficient growth medium for production of a cell monolayer and incubate at 36°C.

**Figure 4.4: Liquid and gaseous nitrogen storage containers (after Freshney)**

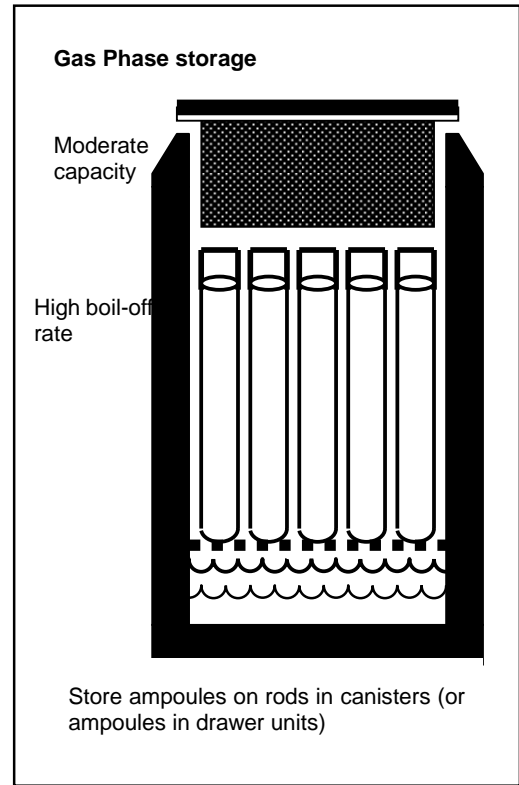
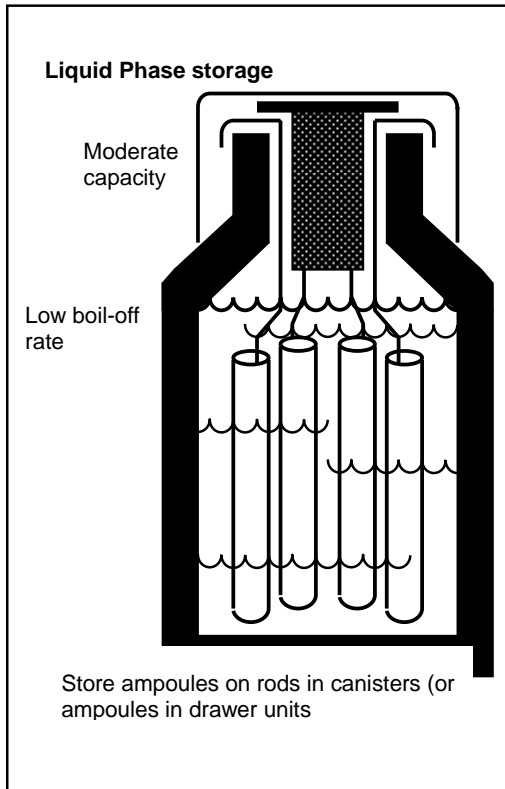

#### 4.2.8 Establishment of cell banks

The RD and L20B continuous cell lines recommended for use by all virus laboratories studying poliomyelitis have been well characterized as regards species identity and lack of contamination by bacteria, mycoplasma and infectious virus.

Regional reference laboratories (RRL) are advised to obtain cell cultures from the official collections. Requests for these cell lines should be submitted to IVB/VAM, WHO, Geneva. A number of RRLs have been requested to establish a master cell bank (MCB) for each cell line. Using scrupulous laboratory techniques of cell culture passage and storage, these RRLs can supply cell cultures directly to the National Laboratories that come within their responsibility. National Laboratories are strongly encouraged to store supplies of these cells, in gaseous or liquid nitrogen, as the working cell bank (WCB) for their own use. Figure 4.5 outlines the formation of the MCB and WCB.

**Figure 4.5: Establishment of a cell bank**

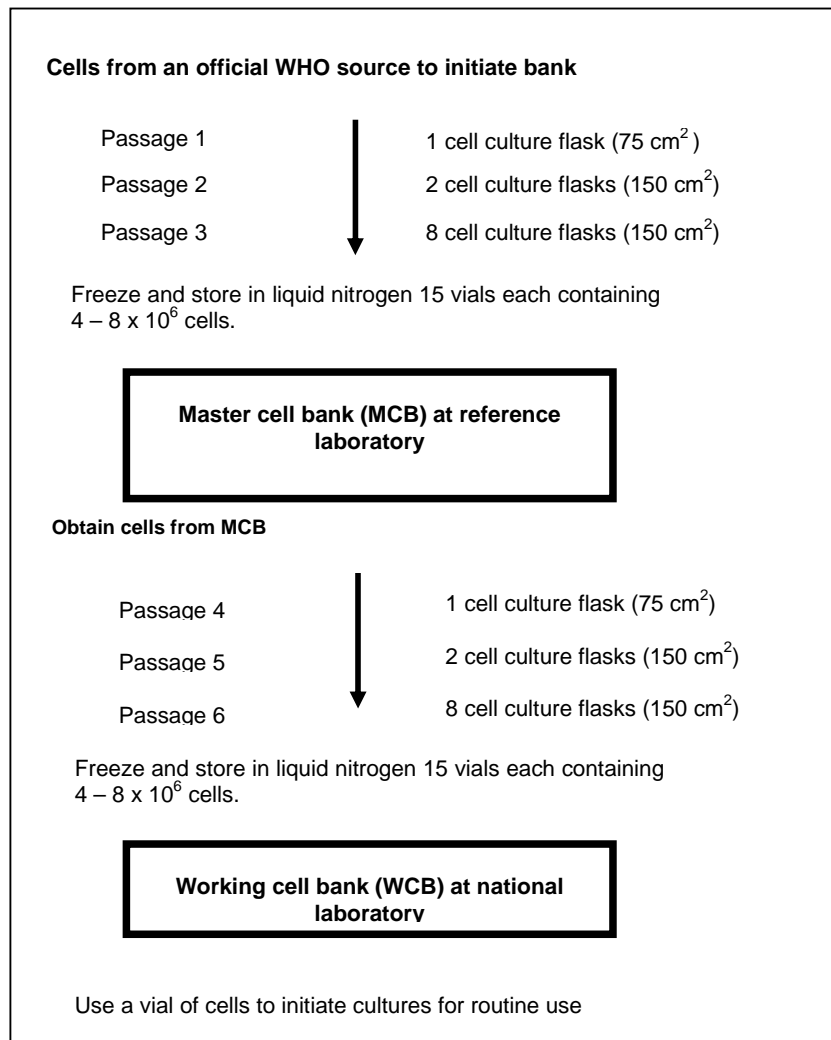

---

The advantages of initiating a cell bank are:

- The expense of transport of original cell lines from official sources is minimized.
- The RRL acts as the MCB repository of well-controlled cell culture stocks.
- The National Laboratory is nearer a supply of good viable cell cultures held at the MCB, but is also encouraged to be self-supporting by producing and storing cells in its own bank (WCB).

### 4.3 Composition of media and other reagents used in cell and virus culture

**Note:** Analytical grade chemicals must be used throughout.

#### 1) Phosphate buffered saline, pH 7.2 to 7.4 (PBS)

This is the simplest of basic salt solutions and is used for washing cells prior to cell disaggregation. PBS in the incomplete and complete form is available commercially. An incomplete solution of PBS contains no calcium or magnesium ions. A complete solution of PBS is used mainly in the preparation of specimen extracts and as diluent for viruses; the presence of calcium and magnesium ions stabilizes viruses, particularly poliovirus and other enteroviruses.

#### 2) Solution A

NaCl	8.00 g
KCl	0.20 g
Na <sub>2</sub> HPO <sub>4</sub> (anhydrous)	0.91 g
KH <sub>2</sub> PO <sub>4</sub>	0.12 g

Dissolve the salts in 600–800 ml distilled H<sub>2</sub>O. Add 2 ml of 0.4% phenol red as pH indicator. Make up to 1000 ml with distilled H<sub>2</sub>O and autoclave at 10 psi (70 kPa) for 15 minutes (110°C). This gives a **working solution of incomplete PBS** (i.e. no calcium or magnesium ions present).

#### 3) Solution B

MgCl <sub>2</sub> ·6H <sub>2</sub> O	0.10 g
--------------------------------------	--------

Dissolve in 100 ml distilled H<sub>2</sub>O. Autoclave at 10 psi (70 kPa) for 15 minutes.

#### 4) Solution C

CaCl <sub>2</sub>	0.10 g
-------------------	--------

Dissolve in 100 ml distilled H<sub>2</sub>O. Autoclave at 10 psi (70 kPa) for 15 minutes.

---

5) **Working solution of complete PBS**

Add 1 part of Solution B and 1 part of Solution C to 8 parts of Solution A.

Alternatively use commercially prepared tablets or powder, following the manufacturer's instructions for reconstitution and sterilization.

6) **Sodium bicarbonate solution**

Together with gaseous CO<sub>2</sub> this provides the buffering system for many cell culture media; it is also an essential metabolite.

NaHCO<sub>3</sub> 7.5 g

Dissolve in 50 ml distilled H<sub>2</sub>O and add 0.2 ml of 0.4% phenol red. Make up to 100 ml with distilled H<sub>2</sub>O, saturate with CO<sub>2</sub> until orange in colour. Dispense in approximately 5 ml volumes in tightly-capped bottles. Autoclave at 10 psi (70 kPa) for 15 minutes.

7) **Eagle's growth medium (GM) and Eagle's maintenance medium (MM)**

Used for culturing RD and L20B cell lines in the presence of CO<sub>2</sub>:

---

	<b>Growth medium</b>	<b>Maintenance medium</b>
Eagle's minimum essential medium (Earle's salts base, no bicarbonate)	83.3 ml	90.3 ml
L-glutamine 200 mM	1.0 ml	1.0 ml
Fetal calf serum	10.0 ml	2.0 ml
NaHCO <sub>3</sub> solution 7.5%	3.5 ml	4.5 ml
HEPES 1M	1.0 ml	1.0 ml
Penicillin/streptomycin solution <sup>a</sup>	1.0 ml	1.0 ml
0.4% phenol red	0.2 ml	0.2 ml

---

<sup>a</sup> Dissolve 1 x 10<sup>6</sup> units crystalline penicillin G and 1 g streptomycin sulphate in 100 ml PBS and sterilize by filtration; distribute into 5 ml volumes and store at -20°C. For use, add 1 ml of this stock solution to 100 ml medium to give a final concentration of 100 units penicillin and 100 µg streptomycin per ml.

**Good laboratory practice:** Some manufacturers include supplementary reagents (such as HEPES and L-glutamine) with their basal media. Always check the manufacturer's formulations before adding further supplements. L-glutamine is unstable. Its half-life in medium at 4°C is about three weeks and at 36°C about one week. Aliquots of sterile L-glutamine stock solutions should be stored frozen at -20°C until use.

### 8) Hank's growth medium (GM) and Hank's maintenance medium (MM)

Used for culturing RD and L20B cell lines in closed systems (tubes and flasks with tightened lids) without CO<sub>2</sub>. Standard incubators can be used.

	Growth medium	Maintenance medium
Minimum essential medium (Hank's salts base, no bicarbonate)	85.3 ml	92.3 ml
L-glutamine 200 mM	1.0 ml	1.0 ml
Fetal calf serum	10.0 ml	2.0 ml
NaHCO <sub>3</sub> solution 7.5%	1.5 ml	2.5 ml
HEPES 1M	1.0 ml	1.0 ml
Penicillin/streptomycin solution*	1.0 ml	1.0 ml
0.4% phenol red	0.2 ml	0.2 ml

### 9) Other antibiotics

Penicillin and streptomycin are the antibiotics most commonly used in cell and routine virus culture work; they are also the least expensive. Gentamicin is more expensive, but it is inhibitory to a wider range of bacteria and it is autoclavable. Gentamicin should be used at a final concentration of 50 µg/ml. Mycostatin may be used at 25 units/ml to counteract fungal and yeast contaminants; however, it is only fungistatic and not fungicidal, is rapidly inactivated at cell culture incubation temperature and some batches are slightly cytotoxic. Fungizone also often produces cytotoxic effects.

### 10) Cell dispersing agents

Trypsin and Versene (EDTA) are commonly used, either separately or combined. The proteolytic enzyme trypsin is particularly suitable for the digestion of cells from whole organs. It is also used for the removal of cells from glass or plastic, but the chelating agent Versene is probably as good. Solutions of trypsin and/or Versene should be prepared in PBS (incomplete) free of calcium and magnesium, as the presence of these ions increases the stability of the intercellular matrix thereby making detachment of the cells from the glass/plastic difficult.

---

**Trypsin:** Dissolve 1 g of Difco 1:250 trypsin in 400 ml PBS (without Ca, Mg) by gentle agitation with a magnetic stirrer for 30 minutes at 36°C. Membrane filter (pore size 0.22 µm), dispense into approximately 5 ml volumes in sealed bottles and store at -20°C.

**Versene:** (EDTA = disodium salt of ethylenediaminetetra-acetic acid). Dissolve 0.1 g of Versene in 10 ml distilled water. Distribute in 0.5 ml volumes in sealed bottles; autoclave 10 psi (70 kPa) for 15 minutes and store at room temperature. For use add 0.4 ml of this 1% solution to 20 ml PBS (without Ca, Mg) to give a final concentration of 0.02%.

#### 11) Phenol red indicator

This indicator of pH is used in cell culture media. Prepare stock 0.4% w/v solution in distilled H<sub>2</sub>O. Distribute into sealed bottles; autoclave at 10 psi (70 kPa) for 15 minutes and store at room temperature. For media preparation, 1–2 ml of this solution per litre is usually adequate.

### 4.4 Cell culture problems: identification and elimination

#### 4.4.1 *Cell cultures degenerate too quickly*

This problem is more frequently encountered with cell cultures prepared in tubes than with flasks. Cell degeneration may lead to rounding up of cells and their detachment from the surface of the culture vessel. The most frequent reasons for rapid cell degeneration are: use of too high a seeding density, failure to change to MM at the proper time, or use of poor quality or too high concentration of fetal calf serum when preparing cultures. Cells rapidly divide, deplete available nutrients in the cell culture medium, and consequently produce acidic growth conditions and early cell death. The optimum cell count and growth conditions are likely to vary between cell lines and different batches of cells. It should be noted that cultures showing rapid cellular degeneration pose problems in poliovirus detection as they may show decreased sensitivity for virus isolation and degeneration may easily be mistaken for virus-induced cytopathic effects. The problem of cell degeneration can usually be overcome by appropriate adjustment of the cell count or fetal calf serum concentration. Laboratories may therefore need to establish those conditions that will allow cells to last for at least 5 to 7 days without degeneration.

#### 4.4.2 *Cell line cross-contamination*

Cell cultures are grown in very rich media that can support the growth of a number of contaminants, from microbiological to other cell lines. Most fungal and bacterial contamination quickly overwhelms a culture and is usually visible to the naked eye within a short period of time. All cultures should be examined by eye and microscopically before being opened. Any cell culture with signs of contamination should be discarded without opening to minimize the chances of the contamination spreading to other cell cultures or media.

---

Whenever rapidly growing, continuous cell lines are maintained in a laboratory there is a risk of cell line cross-contamination. There is a long history of this problem, but it is often ignored. Cross-contamination of cell lines with very different susceptibilities for infection with different viruses (such as L20B and RD cells) will clearly affect interpretation of isolation results. If a laboratory discovers that non-polio enteroviruses grow readily in L20B cells, cell-line cross-contamination must be considered. Simple precautions must be taken to minimize the possibility of cross-contamination, including:

- Only one cell line should be used in a BSC at any one time. After removal of the cell cultures from the cabinet, the cabinet should be swabbed down with a suitable disinfectant and the cabinet run for five minutes before introduction of another cell line.
- Bottles or aliquots of medium should be dedicated for use with only one cell line.
- Regularly return to frozen stocks — never grow a cell line for more than three months or 15 passages from stock passage level, whichever is the shorter period.
- All culture vessels must be carefully and correctly labelled (including name of cell line, passage number and date of transfer), as must liquid nitrogen containers used for long-term cell storage.

If cross-contamination has occurred it can be readily identified by checking the virus susceptibility of the cells. For example L20B cells inoculated with a reference non-polio enterovirus, such as Cozsackie B, should show no cytopathic effect. RD cells have a characteristic mixed morphology and any change to this could indicate cross-contamination.

#### **4.4.3 *Mycoplasma contamination***

Mycoplasma are small, self-replicating prokaryotes (0.3–0.8 µm diameter) that lack a cell wall and have the ability to cyto-absorb onto host cells. Contamination with Mycoplasma is usually not detected unless appropriate tests are carried out or some aspect of cell behaviour (e.g. ability to maintain monolayers) is observed to have changed. Mycoplasma contamination of cell lines is a very common problem, and laboratories that maintain cells through many passages but do not test for Mycoplasma probably have contaminated cell lines. Furthermore, there is a probability that all cell stocks in these laboratories are contaminated, as Mycoplasma spread readily among cell lines through reagents and media, the operator and the work surfaces. The origin of contamination can sometimes be traced back to Mycoplasma present in culture media supplements, such as bovine serum, or human oral Mycoplasma transferred by droplet infection during cell culture.

Mycoplasma contamination of propagated cell cultures is probably unavoidable but some precautions can minimize its occurrence, including:

- Obtaining cell cultures from reputable suppliers, accompanied by documentation of Mycoplasma- negative status and method for testing. Reference laboratories that supply other laboratories with cell cultures must implement Mycoplasma testing. National laboratories need not implement



Mycoplasma testing, once they follow the additional precautions provided below for handling cell cultures.

- Adopting recommended quality control procedures to assure efficacy of sterilization methods for media and glassware.
- Strict adherence to aseptic techniques in handling cultures.
- Preparation of cell cultures within a BSC and minimizing traffic of personnel through work areas when cultures are prepared.
- Avoiding conversation while cell cultures are being prepared.
- Proper disinfecting of work surfaces when work is completed.
- Adhering to recommendations for discarding and replacing cell cultures after every 15 passages.
- Autoclaving before disposal of cell culture materials, and especially autoclaving of any cells found to be contaminated with Mycoplasma.

There are a number of methods for detecting Mycoplasma contaminants and these are summarized below.

**Table 4.3: Summary of methods for detection of Mycoplasma**

Method	Sensitivity	Advantages	Disadvantages
Direct DNA stain (e.g. Hoechst 33258)	Low	Rapid, cheap	Requires use of a fluorescence microscope with correct filter. Can be difficult to interpret
Indirect DNA stain on indicator cells (e.g. Vero, 3T3)	Moderate	Amplifies contamination, so easy to interpret	Indirect and thus time-consuming
Immunofluorescence monoclonal antibody	High	Easy to perform, sensitive	Requires use of a fluorescence microscope with correct filter
Broth and agar culture	High	Sensitive	Relatively slow and may require expert interpretation
ELISA	Moderate	Rapid	Limited range of species detected
PCR	Moderate to high	Rapid	Requires access to PCR facility

---

Cell cultures being checked for Mycoplasma should be cultured in antibiotic-free medium before being assayed as some antibiotics may suppress the growth of Mycoplasma.

#### 4.5 Hoechst 33258 direct DNA stain for Mycoplasma

This technique is rapid (less than 30 minutes), but requires heavy contamination ( $10^6$  mycoplasma/ml) to produce a clear positive result. If the suspect cells are co-incubated for 2–4 days with an “indicator” cell line (such as 3T3) that is particularly suitable for demonstration of positive staining, then sensitivity can be substantially increased. Cell cultures are stained with Hoechst 33258, a fluorescent stain, which binds specifically to DNA. Mycoplasma contain DNA and can be detected readily by their characteristic particulate or filamentous pattern of fluorescence in the cytoplasm or between cells. Mycoplasma-negative cells will show only brightly fluorescent cell nuclei. The Hoechst stain also detects bacterial and fungal contamination, although these are usually obvious from the visible turbidity of the culture medium of infected cells.

Have available the following materials:

- 25 cm<sup>2</sup> flask with cell culture to be evaluated for Mycoplasma. Cells should have been grown to confluence for at least one passage in antibiotic free growth medium.
- balanced salt solution (BSS) without phenol red (BSS-PR), pH 7.0;
- Hoechst 33258 stain (2-(2-(4-hydroxyphenyl)-6-benzimidazolyl-6-*N*-methyl-4-piperazyl)-1-benzimidazol-trihydrochloride: make up as 1 mg/ml (w/v) stock solution in BSS-PR and store at -20°C until ready for use. For use dilute 10 µl in 200 ml BSS-PR. (Note: Hoechst stain may be carcinogenic and must be handled with care);
- deionized or distilled water;
- fresh acetic acid/methanol fixative (cold):  
Add glacial acetic acid to absolute methanol in the ratio of 1:3 (make up the day before use and refrigerate overnight);
- mountant: 50% glycerine in 0.044M citrate, 0.111 M phosphate buffer, pH 5;
- coverslips;
- 8-well chamber slide;
- adjustable pipettors;
- incubator at 36°C;
- refrigerator at 4–8°C;
- epi-illumination fluorescence microscope with 330/380 nm excitation filter and 440 nm barrier filter.

---

### Test procedure

- 1) Trypsinize cell culture and prepare a cell suspension containing  $0.5\text{--}1 \times 10^5$  cells/ml in antibiotic-free cell culture growth medium (*see Section 4.2.5*).
- 2) Using a sterile pipette place 0.5 ml cell suspension in each of the eight wells of a chamber slide. Incubate at  $36^\circ\text{C}$  and observe daily until the cell culture reaches approximately 20–50% confluence.
- 3) Remove and discard the growth medium from each well.
- 4) Gently rinse the monolayers with BBS-PR and discard rinse.
- 5) Add to each well 0.5 ml of freshly made BBS-PR diluted with acetic acid/methanol 50:50 v/v. Rinse the monolayers and discard rinse.
- 6) Add 0.5 ml acetic acid/methanol fixative to each well. Rinse and discard rinse.
- 7) Add 0.5 ml acetic acid/methanol fixative to each well and leave for 10 minutes.
- 8) Remove and discard acetic acid/methanol fixative from each well.
- 9) Wash off acetic acid/methanol with distilled water and discard wash.
- 10) Add 0.1 ml Hoechst 33258 stain in BSS-PR to each well, ensuring that the stain covers the complete surface of the well, and leave for 10 minutes at room temperature.
- 11) Remove stain and discard.
- 12) Rinse monolayer with water and discard rinse.
- 13) Peel off plastic chamber and silicone seal. Add a minimal volume of mountant, sufficient to just cover each monolayer, and place a coverslip on the slide.
- 14) Examine the slide using a fluorescence microscope with 330/380 nm excitation filter and LP 440 nm barrier filter. At least 500 x magnification (10 x ocular and 50 x objective) will be required to find evidence of Mycoplasma staining. Examine for evidence of extranuclear fluorescence. Mycoplasmas give pinpoint or filamentous fluorescence over the cytoplasm and, if heavily infected, fluorescence may also be seen in between cells. Since the Hoechst stain will stain all DNA, the nucleus of all cells should also stain brightly. Mycoplasma negative cells will show brightly staining nuclei and no staining in the cytoplasm.

### 4.6 MYCO-TEST immunoassay for Mycoplasma detection

WHO doesn't endorse the use of any particular commercial assay but the MYCO-TEST immunoassay is one produced by ICN (ImmunoMark MYCO-TEST, Cat. No. 3020000) that some laboratories find easy to use. The test is reported to have high sensitivity and is based on immunofluorescence staining of cells using monoclonal antibodies against Mycoplasma.

Stained cells are examined microscopically for the presence of characteristic yellow-green fluorescence seen on cell perimeters and in inter-cellular spaces.

---

Have available a MYCO-TEST kit which contains the following materials:

- 2 ml monoclonal CCM-2 Fluos conjugate diluted in protein-stabilized buffer with Evans blue counterstain;
- 2 ml goat anti-mouse IgG FITC conjugate diluted in protein-stabilized buffer with Evans blue counterstain;
- 2.5 ml mounting medium;
- protocol booklet.

Have available the following additional materials:

- 25 cm<sup>2</sup> flask with cell culture to be evaluated for Mycoplasma that has been grown for at least two days in antibiotic-free growth medium;
- 10-well Teflon coated slide;
- PBS;
- 70% cold ethanol (-20°C);
- pasteur pipettes or cell scraper;
- pipettor with 20 µl tips;
- incubator at 50°C;
- epi-illumination fluorescent microscope (FITC filters).

#### **Test procedure**

- 1) Remove and discard growth medium from 25 cm<sup>2</sup> cell culture flask to be tested.
- 2) Add approximately 0.5 ml of PBS to the flask.
- 3) Scrape cells from flask by using a cell scraper or an adapted sterile Pasteur pipette (with L-shape bend created with bunsen burner). Mix cells and PBS to form a cell suspension.
- 4) Using a pipettor add 20 µl cell suspension to at least 2 wells of a clean, labelled Teflon coated slide.
- 5) Dry the slide for 45 minutes in a 50°C incubator (if available), or at room temperature.
- 6) Place the slide in a slide jar and fix for 60 seconds in -20°C cold 70% ethanol.
- 7) Allow the slide to dry.
- 8) Stain the slide using one of the following procedures:

One-step staining in which a fluorochrome-labelled monoclonal antibody is used for fast screening of suspected positives.

- a) Add one drop of the CCM-2 Fluos-labelled monoclonal antibody (Reagent 1) to the fixed cell preparation. Ensure that the reagent covers the entire well area.

- 
- b) Incubate for 20 minutes at room temperature in a humidified container. (Reagent drying on the specimen may cause non-specific staining).
  - c) Carefully rinse the slide with phosphate buffered saline and wash twice for a total of two minutes in a slide staining dish of phosphate buffered saline.
  - d) Leave the slide to dry at room temperature.
  - e) Place one drop of mounting medium (Reagent 3) in the centre of each well and place a coverslip over the mounting fluid. Avoid trapping air bubbles.

**Two-step staining test using the labelled monoclonal antibody and a fluorochrome-labelled secondary antibody for “extremely sensitive” Mycoplasma detection.**

Follow the same procedure for **one-step** staining from steps a) to e).

- f) Add one drop of the goat anti-mouse IgG FITC conjugated monoclonal antibody (Reagent 2) to the fixed cell preparation. Ensure that the reagent covers the entire well area.
  - g) Incubate for 20 minutes at room temperature in a humidified container. (Reagent drying on the sample may cause non-specific staining)
  - h) Carefully rinse the slide with phosphate buffered saline and wash twice for a total of 2 minutes in a slide staining dish of phosphate buffered saline.
  - i) Leave the slide to dry at room temperature.
  - j) Place one drop of mounting medium (Reagent 3) in the centre of each well and place a coverslip over the mounting fluid. Avoid trapping air bubbles.
- 9) For best results slides should be read immediately after staining. Examine the slide using a fluorescence microscope. Stained Mycoplasma should be visible easily using at least 500X magnification (10X ocular and 50X objective). If Mycoplasma contamination exists, a characteristic yellow-green fluorescence is seen on cell perimeters and between counter-stained cells, which will appear bright red.

#### **4.7 PCR assay for Mycoplasma detection**

There are numerous PCR-based methods for detection of Mycoplasma cited in the scientific literature. There are also a number of commercially available PCR-based assays that have the convenience of providing most of the reagents and controls needed to perform the assay and which appear to have high sensitivity for detecting Mycoplasma contamination. WHO doesn't endorse the use of any particular commercial assay, but the VenorGeM Mycoplasma Detection Kit is an example of a commercial kit which some laboratories find easy to use. VenorGeM is reported by the manufacturer to give a positive reaction with as little as 1–5 fg of Mycoplasma DNA (equivalent to 2–5 Mycoplasma organisms per sample volume). The

---

VenorGeM kit is also reported to have ability to detect a range of Mycoplasma, including Acholeplasma and Ureaplasma species, both commonly found in contaminated cell cultures.

Have available the following items:

- 25 cm<sup>2</sup> flask with cell culture to be evaluated for Mycoplasma;
- VenorGeM commercial kit containing:
  - oligonucleotide primer set and nucleotides
  - lyophilised primer set and deoxynucleotide triphosphates dATP, dCTP, dGTP and dTTP at optimized concentrations
  - PCR 10X reaction buffer, sterile
  - 100 mM tris-HCL (pH 8.5)
  - 500 mM KCL
  - 30 mM MgCl<sub>2</sub>
  - Positive control DNA
  - lyophilised DNA-fragment of Mycoplasma orale (non-infectious)
  - Internal Control DNA
  - lyophilised plasmid including Mycoplasma specific primer sequences and an internal sequence of the HTLV-1 tax gen with a size of approximately 191 bp
- Other materials/equipment needed but not provided in the VenorGeM kit:
  - RNase-DNase free water
  - 1U Taq DNA polymerase
  - biosafety cabinet, BSC
  - variable volume pipettors; 0.5-10 µl, 10-200 µl
  - sterile ART tips
  - thermocycler machine
  - heating block
  - screw-capped or locking tubes 1.5 ml (sterile)
  - tube racks
  - microcentrifuge
  - microcentrifuge tubes

---

## Test procedure

### *Preparation of samples*

- 1) Working in a BSC, transfer 100 µl of medium from the 25 cm<sup>2</sup> cell culture flask into a labelled, sterile 1.5 ml microcentrifuge tube. Discard the remainder of the medium from the flask.
- 2) Add approximately 0.5 ml of PBS to the flask and scrape cells from the flask into the PBS by using a cell scraper or an adapted sterile Pasteur pipette (create L-shape bend by softening with a bunsen burner). Mix the PBS and scraped cells to form a cell suspension.
- 3) Transfer 100 µl of cell suspension into a labelled, sterile, 1.5 ml microcentrifuge tube.
- 4) Incubate both samples (i.e. separate microcentrifuge tubes with cell suspension and medium) in a heating block at 95°C for five minutes.
- 5) Centrifuge (five seconds) the samples to pellet cellular debris and store at 4°C until ready for use.

**Good laboratory practice when doing PCR:** Because the PCR technique involves amplification, PCR-product carryover (cross-contamination) represents a significant problem.

Observing the following good laboratory practices can diminish the problem:

- Use a separate room or containment unit (biological safety cabinet equipped with UV light) for pre- and post-PCR procedures.
- Use separate sets of pipettors and other equipment for pre-and post-PCR procedures.
- Aliquot reagents and store to minimize the number of repeated samplings.
- Prepare and aliquot reagents in an area that is free of PCR amplified products.
- Always use aerosol-resistant tips.
- Wear gloves (talc free) and change frequently.
- Uncap tubes carefully to prevent aerosols.
- Minimize sample handling.
- Add non-sample components to the reaction tubes before adding the sample and controls.
- Cap each tube after the addition of sample before proceeding to the next sample.
- Use a positive control that amplifies consistently.
- Use a negative control.
- Include one or more reagent controls with each amplification. Reagent controls should contain all of the necessary components for PCR except the template RNA.

---

## PCR reactions

- 1) Rehydrate PCR primer set, nucleotides and positive control DNA in a PCR-Clean Area.
  - Before rehydration, briefly centrifuge all tubes to ensure that lyophilised pellets are spun down.
  - Use the following procedure when rehydrating materials: add the appropriate amount of H<sub>2</sub>O and allow the tube to sit at room temperature for 5 minutes. Mix the solution by vortexing a few seconds or by pipetting up and down repeatedly to completely dissolve the DNA. Briefly centrifuge again.
  - Rehydrate PCR primer set and nucleotides with 130 µl sterile RNase-DNase free H<sub>2</sub>O. Aliquots of primers and nucleotides should be prepared and stored frozen until ready for use.
  - Rehydrate positive control with 100 µl sterile RNase-DNase free H<sub>2</sub>O.
  - Rehydrate internal control with 220 µl of sterile RNase-DNase free water.
- 2) Prepare the PCR master mix in sterile 1.5 ml tubes, preparing sufficient volume to allow 48 µl per sample and control:

Reagents	Volume per reaction
10 x PCR reaction buffer	5.0 µl
Mycoplasma Primer set and dNTPs	5.0 µl
Taq DNA polymerase	0.2 µl
Internal Control DNA	2.0 µl
RNase-DNase free water	35.8 µl
Total volume	48.0 µl

Aliquot 48 µl of master mix into each PCR reaction tube required, including tubes for controls.

- 3) Add samples and controls to the PCR master mix in the sample preparation area:
  - Have available the samples, controls and master mix on a rack in an ice bath.
  - Working in a BSC, add 2 µl of each sample and control to appropriately labelled PCR tubes containing reaction mix. Include 2 µl of kit positive control and 2 µl of RNase-DNase-free water as a negative control.
- 4) Run samples on Thermocycler using the following parameters. Run time is approximately three hours:
  - Cycle 1: 94°C for 2 minutes, 55°C for two minutes, 72°C for three minutes;
  - Cycle 2 to 35: 94°C for 30 seconds, 55°C for one minute, 72°C for one minute;
  - hold at 72°C for four minutes;
  - hold at 4°C until tubes are removed.



- 
- 5) Run 10 µl of all PCR amplified samples on 2% agarose gel at 110V for one hour. Include a 100 base pair ladder.
  - 6) Stain gel with ethidium bromide and photograph for permanent record.

### **Interpretation**

The results are interpreted by comparing the presence and size of PCR products from test samples to those of positive control reactions. The positive control should show a strong 270-bp band and the negative control should show no bands in this region. The Internal Control DNA should produce a 191 base pair band, indicating no inhibition of the PCR reaction. Any samples containing Mycoplasma DNA will produce a distinct and usually strong 270 base pair band, i.e. at the same position as seen with the positive control. Uninfected samples will show no band at this size. The VenorGeM Mycoplasma assay is designed for high sensitivity and is therefore prone to non-specific annealing. Bands of various lengths that are less intensive can be produced but do not indicate positive results. Self-annealing of primers can produce a produce of 80–99 base pairs, but this also does not affect the precision or results of the test.

---

## 5. Evaluating cell-line sensitivity

With global eradication of wild type poliovirus approaching, false-negative virus isolation results can have serious consequences. Therefore, optimum sensitivity of the entire virus isolation procedure is crucial in virological surveillance. Routine monitoring of the sensitivity of cell lines for virus isolation is an important component of the laboratory's quality assurance programme. It provides reassurance that a cell line retains the ability to detect polioviruses, even if present at low titre. A well-characterized reference virus preparation of known and reproducible titre, as described below, should be used to periodically evaluate cell-line sensitivity.

Multiple factors can adversely affect cell-line sensitivity including: Mycoplasma contamination; quality of growth media (e.g. fetal calf serum, water, pH); growth conditions (e.g. temperature of incubation). This is one reason for monitoring and keeping records of these culture conditions. The sensitivity of the cell culture for poliovirus detection should always be evaluated after the introduction of a new lot of serum, new incubator, new technician or any other major change in the procedure. A decrease in cell-line sensitivity is not evident from microscopic examination of cells so morphological or other physical characteristics cannot be used as a marker for cell sensitivity. However, any cell culture that is visually abnormal and must be used for virus isolation in exceptional situations should have its sensitivity to poliovirus tested.

The sensitivity should be known for all frozen stocks of a cell line and should be evaluated whenever fresh cells are resuscitated or received in the laboratory. It is recommended that cells be evaluated approximately midway through their expected use of 15 passages. Data sheets and summaries of any corrective action should be retained for documentation, in accordance with accreditation requirements for WHO polio network laboratories.

### 5.1 Selection of reference standard for quality control of cell lines

Authenticated Sabin Poliovirus Reference Strains of known titre can be procured from the National Institute for Biological Standards and Control (NIBSC), United Kingdom (see Section 5.6 below for procurement information). Laboratories should order at least five ampoules of each serotype from NIBSC. Immediately upon receipt, ampoules should be stored unopened at -20°C until they are ready to be used. The authenticated strains serve two main purposes in the laboratory: a) a source of reference virus with validated and authenticated identity which can be used to prepare working stocks of laboratory quality-control standards and other

---

reference materials; and b) material of known titre to calibrate working stocks of laboratory quality-control standards.

Do the following with the five ampoules of each authenticated Sabin virus serotype that has been received:

- Two ampoules are retained for future use and should remain frozen at  $\leq -20^{\circ}\text{C}$  (i.e. ampoules are not opened or their contents manipulated).
- Two ampoules are thawed, and sterile pipettes or pipettors with sterile ART-resistant tips are used to mix their contents and prepare multiple 0.1 ml aliquots that are then stored frozen at  $\leq -20^{\circ}\text{C}$  (Note: total of 16 aliquots).
- One ampoule is used to grow up virus stocks in RD and L20B cell lines to serve as the laboratory's quality-control standards and reference virus stock for these cell lines (see Section 5.2).

## 5.2 Preparation of laboratory quality-control standards

Have available the following items:

- 1 ml and 10 ml sterile plastic disposable pipettes;
- 50 ml sterile, screw-capped, centrifuge tube (one for each serotype) and each cell line;
- 250 externally threaded, screw-capped, storage vials (1.8–2.0 ml size) for each serotype and each cell line;
- 1 ampoule of NIBSC Sabin Poliovirus Reference Standard of each serotype;
- 75 cm<sup>2</sup> flasks (one for each serotype) with a confluent layer of healthy L20B cells and RD cells in 25 ml maintenance medium.

**Do the following:**

- Examine the cells for quality (i.e. an entire monolayer of healthy cells) and absence of contamination as determined by visual inspection. A suitable monolayer for use would be one formed within at least two days of seeding.
- Label the flasks that will contain the inoculated culture.
- Working in a BSC with only one serotype at a time, use a sterile plastic disposable pipette to mix the contents of an ampoule of NIBSC Sabin poliovirus reference standard. Transfer half the contents of the ampoule (approximately 0.4 mls) to a 75 cm<sup>2</sup> flask of either L20B or RD cells. Retain the other half ampoule of material for inoculating the other cell line at a later time, storing it at 4°C if the other cell line is to be handled on the same day, or at  $\leq 0^{\circ}\text{C}$  if it is to be used on another day.
- Incubate the flask, containing the inoculated culture, at 36°C.
- Examine the inoculated culture daily, using an inverted microscope, for the appearance of cytopathic effect (CPE).
- When 75 to 100% of cells show CPE (3+ to 4+ CPE), transfer the flask to  $\leq 0^{\circ}\text{C}$ . Freeze and thaw the contents of the flask, shaking the flask when it is semi-thawed to ensure that all cells are disrupted. Repeat two additional times.

- 
- Working in a BSC, use a sterile 10 ml pipette to mix the contents of the flask. Transfer the contents to a labelled 50 ml centrifuge tube.
  - Spin for 20 minutes at 1500g<sup>1</sup> in a refrigerated centrifuge after ensuring that centrifuge caps are securely in place and centrifuge buckets are sealed.
  - Label each storage vial with the name of the cell line, the name of the virus preparation and the date.
  - Working in a BSC, transfer aliquots of the supernatant into labelled storage vials (0.1 ml supernatant per vial to give a total of 250 aliquots).
  - Store the aliquots of the virus preparation, which should be used subsequently as the laboratory quality control standard, in a -20°C freezer designated for storage of infectious materials.

### 5.3 Titration of laboratory quality control standard

The procedure outlined below is used:

- 1) For initial determination and validation of the titre of the laboratory quality control standard:

Before being accepted for routine use, the titre for the quality-control standard must be shown to be reproducible on at least three separate occasions when tested in parallel with the same NIBSC reference standard that is used to validate the titre on all three occasions. The expected titres for the NIBSC reference standard are:

- Sabin type 1: 5.1 log<sub>10</sub> CCID<sub>50</sub>/0.1ml in RD cells and 4.9 log<sub>10</sub> CCID<sub>50</sub>/0.1 ml in L20B cells;
- Sabin type 2: 5.1 log<sub>10</sub> CCID<sub>50</sub>/0.1ml in RD cells and 4.8 log<sub>10</sub> CCID<sub>50</sub>/0.1ml in L20B cells;
- Sabin type 3: 5.3 log<sub>10</sub> CCID<sub>50</sub>/0.1ml in RD cells and 4.9 log<sub>10</sub> CCID<sub>50</sub>/0.1ml in L20B cells.

The titre of the quality-control standard is likely to be higher than the NIBSC reference standard; both titres should not vary by more than +/- 0.5 log<sub>10</sub> when tested on the three occasions. Once these criteria are met, the expected titre to be assigned to the laboratory quality-control standard will be the average of the titres obtained on those three occasions.

- 2) For subsequent routine monitoring of cell-line sensitivity, when only the laboratory quality-control standard of established, reproducible titre needs be used for testing:

---

<sup>1</sup> g = relative centrifugal force; to convert to RPM use the following formula:

$$g = (11.7 \times 10^{-7}) RN^2$$

where R = radius in mm from centrifuge spindle to extreme point on the tube, and N = speed of centrifuge spindle in RPM.

---

Have available the following items:

- 1 ml and 10 ml plastic disposable pipettes;
- 5 ml sterile tubes with caps for dilution;
- vortex mixer;
- sterile 96-well flat-bottomed cell-culture microtitre plates with lids;
- sterile, non-toxic plate sealers (if CO<sub>2</sub> incubator is not to be used);
- pipettors with aerosol resistant tips (ARTs)
- flask with confluent layer of healthy cells of the type for which sensitivity for virus isolation is being evaluated; will need sufficient cells to prepare 10 mls/microtitre plate of a cell suspension containing 1–2 x 10<sup>5</sup> cells/ml (*see Section 4*);
- maintenance medium;
- low titre Sabin poliovirus reference strain.

Do the following:

- Label dilution tubes 10<sup>-2</sup>–10<sup>-8</sup> (*see Figure 5.1*).
- Dispense 9.0 ml medium to tubes 1–7.
- Rapidly thaw one aliquot of laboratory quality-control standard virus for one serotype. For a calibration experiment all three serotypes need to be tested.
- To the thawed standard virus, add 0.9 ml of medium and mix. This is the 10<sup>-1</sup> dilution of the standard virus.
- For a calibration experiment, also thaw and dilute an aliquot of the NIBSC standard virus of the same serotype in an identical manner.
- Add 1.0 ml of virus to the first tube using a sterile pipette or pipettor with ART tip.
- Cover the tube and vortex gently.
- Take another pipette/pipette tip, transfer 1.0 ml to the second tube, and discard pipette/pipette tip.
- Cover the tube and vortex gently.
- Repeat dilution steps, transferring 1.0 ml each time and always changing pipette/pipette tip between dilutions, up until tube 7 (*see Figure 5.1*).
- Add 100 µl of virus dilutions to wells 1 to 10 in rows A to H – that is, 20 wells per dilution (*see Figure 5.2*).

**To obtain valid test results:**

- dilutions 10<sup>-4</sup> to 10<sup>-7</sup> are put on the plate when testing the NIBSC Reference Standard;
- dilutions 10<sup>-5</sup> to 10<sup>-8</sup> are put on the plate when testing the laboratory quality-control standard prepared in Section 5.2.
- Add 100 µl of maintenance medium to wells A11 to H12 in rows A to H for the cell controls.

Prepare a suspension of approximately  $1-2 \times 10^5$  cells /ml, calculating at least 10 ml per plate (see Section 4).

- Label the edge of the microtitre plate as indicated in Figure 5.2.
- Add 100  $\mu$ l of cells from a cell suspension containing  $1-2 \times 10^5$  cells /ml to all wells in rows A to H on the plate.
- Cover the plate with non-toxic sealer (if not using a CO<sub>2</sub> incubator) and incubate at 36°C.
- Examine for development of CPE, using an inverted microscope, and record daily readings for 5–7 days. For a valid test, the cell control should have a complete monolayer of healthy cells.

**Figure 5.1: Preparation of virus dilution of Sabin poliovirus reference strain**

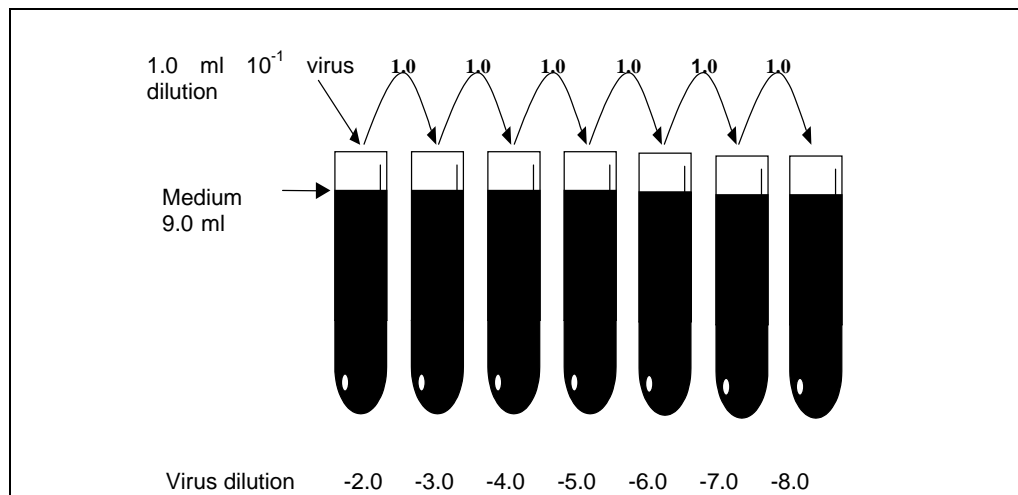

**Figure 5.2: Plate layout for titration of laboratory quality control standard**

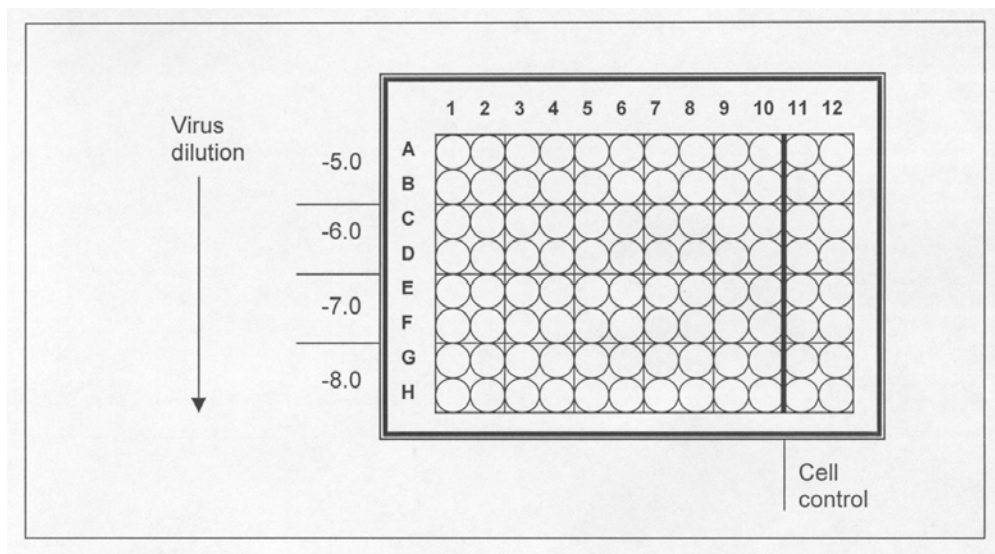

**Figure 5.3: Example of results of titration of Sabin poliovirus reference standard**

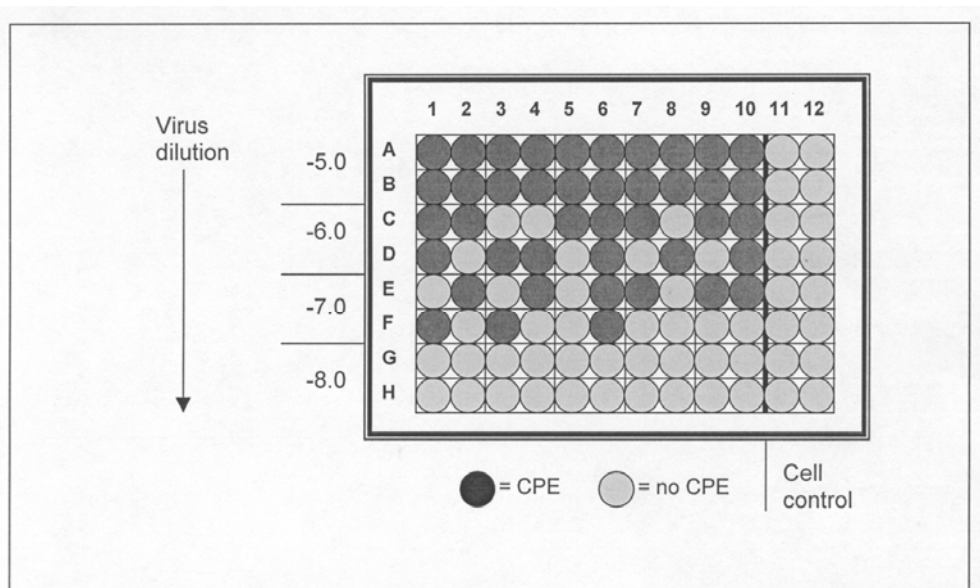

#### 5.4 Calculation of the virus titre by the Kärber formula

$\log \text{CCID}_{50} = L - d(S - 0.5)$ , where:

L = log of lowest dilution used in the test

d = difference between log dilution steps

S = sum of proportion of “positive” tests (i.e. cultures showing CPE)

In this example:

$L = -5.0$ ;  $d = 1.0$ ;  $S = 1 + 0.65 + 0.45 + 0 = 2.10$

$\log \text{CCID}_{50} = -6.60$ ; Virus titre =  $10^{6.60} \text{CCID}_{50} / 0.1 \text{ ml}$

#### 5.5 Interpreting data on cell-line sensitivity and troubleshooting

**Validity of cell sensitivity test:** There are two common reasons for a test producing results that are invalid for titre determination. The end-point estimation using the Kärber method requires the observation of both a dilution with 100% and 0% CPE. If the titre range for the plated virus dilutions is too low or too high, either the 100% or 0% CPE end-points may not be observed. This can occur if the laboratory quality-control standard has an unusually high or low titre. The recommended dilutions to be plated in the procedure (*as outlined in Section 5.3 and Figure 5.2*) are based on typical reference materials. It is completely permissible to change the recommended plated dilutions during routine testing by either one dilution higher or lower, as appropriate, to obtain valid test results. The titre range in Figure 5.1, however, should never be changed. The second reason for an invalid test is the occasional observation of  $\geq 90\%$  or  $\leq 10\%$  CPE at the first or last dilution respectively. Such results can be accepted, with the next lower dilution considered

---

as 100% CPE or the next higher dilution as 0% CPE, for the purpose of calculation of the titre. The titre is calculated in an identical manner to the process outlined in Section 5.3.

**Testing of NIBSC Reference Standard:** If the initial testing of the NIBSC Reference Standard gives titre results that are consistently less than 0.5 log<sub>10</sub> below the listed expected value for any virus or cell line, then a cell-sensitivity problem or assay-performance problem exists and testing of the laboratory quality-control standard should be discontinued until the problem is identified and corrected. It is strongly recommended that the laboratory review assay procedures immediately and notify the regional laboratory coordinator of these results. If there are no problems with assay performance evident from the review, a cell-culture problem is likely. This can be due to cells or media components but resolution of the problem is a very high priority.

**Testing of the laboratory quality control standard:** Once the titre of the laboratory quality-control standard has been established, the standard can be accepted for routine use. (Note: Laboratories with an unreliable electricity supply should be aware that repeat freezing and thawing of the laboratory control standard may affect the titre and its performance.) On each occasion that cell sensitivity is evaluated, the titre of the laboratory control standard is compared to the established reference value. If the titre is the same, or within  $\pm 0.5 \log_{10}$  of the expected reference value, it is inferred that there is no decline in cell-line sensitivity, nor any procedural problems in carrying out the test. Titres of 0.5 log<sub>10</sub> or more above the expected titre may be due to procedural problems in preparing virus dilutions. Titres 0.5 log<sub>10</sub> or less below the expected titre may be evidence of a decline in cell sensitivity, and a fresh aliquot of the reference standard should be titrated, following the above procedures to exclude the possibility of human error. At the same time, records on possible changes in culture conditions should be evaluated. If the titre is reproducibly low, and the effect of putative temporary changes in culture conditions can be eliminated, the cell line should be replaced with one of higher sensitivity from liquid nitrogen stocks available in the local laboratory. Alternatively, new cell-line stocks should be ordered from a WHO Regional Reference Poliovirus Laboratory, then tested and shown to have appropriate sensitivity before being accepted for routine use. The Regional Laboratory Coordinator should also be notified and the possible need for retesting of specimens determined.

## 5.6 Procurement of reference poliovirus strains

Sabin Poliovirus Reference Strains are available from NIBSC. They are provided in ampoules, each containing of 0.8ml, and are shipped on dry ice. When ordering, use the reference numbers and contact information below.

### *Reference numbers:*

- Sabin 1 NIBSC Reference Number 01/528
- Sabin 2 NIBSC Reference Number 01/530
- Sabin 3 NIBSC Reference Number 01/532.



---

***Contact address:***

Dr. Javier Martin,  
Division of Virology,  
National Institute for Biological Standards and Control, NIBSC,  
Blanche Lane,  
South Mimms,  
Potters Bar,  
Hertfordshire EN6 3QG,  
United Kingdom

Telephone: +44 1707 641 401;

Fax: +44 1707 646 730

Email: [jmartin@nibsc.ac.uk](mailto:jmartin@nibsc.ac.uk)

---

# 6. Specimen receipt and processing

## 6.1 Receipt of specimens

On arrival in the laboratory, shipping cartons or carriers must be immediately unpacked in a designated area equipped with a discard container, alcohol swabs and paper towels. Safety of laboratory workers is the prime concern and, if available, a Class II Biosafety Cabinet (BSC) should be used to limit exposure of laboratory staff to potential pathogens. If a BSC is not available a clean workbench can be used. This should have a surface covering that can be easily disinfected using common laboratory disinfectants (70% alcohol, sodium hypochlorite solution, 2% glutaraldehyde solution, etc.) and should be located away from areas used for other laboratory activities. Enteroviruses are not inactivated by alcohol per se, but a 70% solution is an effective antibacterial and antifungal disinfectant and will inactivate enteroviruses by desiccation if the solution is allowed to completely dry. Unpacking and recording of specimens should preferably be carried out by two persons: one records data while the other is gloved and is responsible for opening the package and checking for breakage and leakage of sample containers, and contamination of accompanying documents. Any contaminated paperwork should be placed temporarily in the BSC while the information is manually recorded on a clean sheet of paper. Contaminated documents should be handled in the same manner as infectious wastes.

### 6.1.1 Recording receipt of specimens

Information on specimen labels must be carefully checked to ensure that it matches information on the request forms. The following information should be included on the laboratory request form accompanying the specimen:

- EPIId number (in an agreed format);
- patient name (preferably including English script);
- province (or region) of report;
- town/district of report;
- province (or region) of residence of the case;
- town/district of residence of the case;
- country code;
- whether the case has been immunized;
- date of last oral polio vaccine (OPV);

- 
- specimen from an acute flaccid paralysis (AFP) case, contact, or other specified source;
  - if it is a contact, EPIId number of the related case;
  - specimen type (stool, rectal swab, etc.);
  - date of onset of paralysis (exact date, the month is minimum requirement);
  - date of specimen collection;
  - date specimen sent to laboratory.

On receipt of a specimen the laboratory should record the following additional information:

- date specimen received in laboratory;
- specimen arrived frozen or with ice present (for feedback to EPI) (yes/no);
- specimen arrived in amount large enough for full laboratory analysis (yes/no);
- specimen arrived with no evidence of leakage or desiccation (yes/no);
- whether this is the first or second specimen received from the case.

Each specimen should be allocated a specific identification number that is entered in the laboratory “day book”, on the accompanying request form and on the specimen container. This may be an abbreviated version of the EPIId number or a sequential in-house number. This number must be used on all containers, centrifuge tubes, cell culture tubes and vials throughout subsequent laboratory procedures.

## 6.2 Specimen preparation

Specimens require pretreatment before inoculation, and all faecal samples must be treated with chloroform, to which enteroviruses are resistant. In addition to removing bacteria and fungi, this method removes potentially cytotoxic lipids and dissociates virus aggregates.

To protect laboratory workers all manipulation of faecal material and faecal suspensions must take place inside a functional Class II BSC. The effectiveness of a BSC is dependent on its position, correct use and regular testing and maintenance. Cabinets should be sited away from doors and through traffic. Movement in the area of a BSC will disturb airflow, so access to the area should be restricted to essential personnel. When working within a BSC it is important to minimize the potential for contamination of the working environment and cross-contamination between specimens. This can be greatly assisted by the following:

- Switch on cabinets 10–20 minutes before use and leave on for a similar period afterwards.
- Do not make rapid movements within the cabinet as this disrupts airflow.
- Manipulate fluids slowly and gently to avoid creating aerosols.
- Do not overcrowd the cabinet and never obstruct the front opening.
- Organize the work area so that sterile reagents and samples do not come into contact with each other (e.g. pots for liquid waste to the left and sterile media to the right with samples handled centrally).

- 
- Periodically test cabinets for filter integrity (e.g. oil mist test) and operator protection (e.g. potassium iodide release test). These tests are described in BS2756 and should be repeated when the cabinet is moved or the laboratory layout altered significantly.
  - Clean and decontaminate the cabinet inner surfaces (both horizontal and vertical) after every working session, and periodically (e.g. once per month) decontaminate and clean the tray under the BSC working surface.
  - Replace the BSC front cover when not in use to prevent entry of dust and aerosols.

### 6.2.1 *Preparation of faecal samples for virus isolation*

Have available the following items:

- 15 ml or 50 ml polyethylene chloroform-resistant centrifuge tubes
- 1 or 5 ml glass pipette for aliquoting of chloroform
- 5 ml and 10 ml pipettes
- wooden spatula
- externally threaded, screw-capped storage vials (5 ml)
- glass beads, approximately 3 mm diameter
- PBS with antibiotics (*see Section 6.3*)
- chloroform

Do the following:

- Label centrifuge tubes with sample numbers.
- Add 10 ml PBS, 1 g of glass beads and 1 ml chloroform to each tube.
- Working in a BSC, transfer approximately 2 g of each faecal sample to a labelled centrifuge tube (ensure that the number of the original sample matches the number on the centrifuge tube).
- Retain the remaining original sample, preferably in its original container, for storage at -20°C.
- Close centrifuge tubes securely and shake vigorously for 20 minutes using a mechanical shaker.
- Spin for 20 minutes at 1500 g in a refrigerated centrifuge ensuring that centrifuge caps are securely in place and centrifuge buckets are sealed<sup>1</sup>. Working in a BSC, transfer supernate from each sample into two labelled externally threaded screw-capped storage vials (If supernate is not clear, repeat chloroform treatment).
- Store one faecal suspension at -20°C as a back up and store the other at 4 to 8°C.

---

<sup>1</sup>  $g$  = relative centrifugal force; to convert to RPM use the following formula:  
 $g = (11.7 \times 10^{-7}) RN^2$  where  
 $R$  = radius in mm from centrifuge spindle to extreme point on the tube, and  
 $N$  = speed of centrifuge spindle in RPM.

---

### 6.2.2 *Storage of faecal samples and suspensions*

Stool specimens should be processed, following WHO protocol, within the first working day after arrival or as soon as possible after arrival in the laboratory so that faecal suspensions will be available for inoculation onto cell cultures. It is not possible, however, to have cell monolayers ready for inoculation at all times, so faecal suspensions sometimes must be stored for a period of time before they can be used to inoculate cells.

If the expected delay before cell culture inoculation is 48 hours or less the faecal suspension kept for inoculation should be stored refrigerated at 4 to 8°C. If the expected delay is greater than 48 hours, both aliquots of faecal suspension should be stored frozen at -20°C.

To allow re-investigation of specimens giving anomalous or queried results, it is necessary to retain original stool specimens **for at least six months, and preferably 12 months**, after receipt. Ideally these should be stored frozen at -20°C in their original containers. Since many laboratories have restrictions on the volume of -20°C storage space available, it may be necessary to store original stool specimens in smaller containers, such as appropriately labelled 2 to 5 ml externally threaded screw-capped vials.

Great care must be taken to avoid cross-contamination of stool specimens during the transfer of material from the original containers to the storage vials.

Faecal suspensions should be stored at -20°C for **at least three months** after receipt of the specimen, or until complete results (including intratypic differentiation (ITD) and sequencing if necessary) are available. Faecal suspensions should not be stored for periods of greater than 12 months as this is a waste of valuable -20°C storage space.

**Good laboratory practice:** All faecal material and faecal extracts must be stored in adequately labelled containers (no more than three-quarters full to allow for expansion) in freezers that are dedicated for the storage of infectious materials. They must never be stored in freezers containing materials used for cell culture. Contents of the freezers should be listed, and the freezers emptied of time-expired material on a regular basis.

---

### 6.3 Composition of reagents used in specimen processing

#### 1) Phosphate buffered saline, pH 7.2 to 7.4

Phosphate buffered saline (PBS) is often described in two forms, as incomplete or complete solutions. Both of these forms are available commercially. An incomplete solution of PBS contains no calcium or magnesium ions. A complete solution of PBS contains calcium and magnesium ions and is used for preparation of faecal suspensions and as diluent for viruses. The presence of calcium and magnesium ions stabilizes viruses, particularly poliovirus and other enteroviruses.

#### 2) Solution A

NaCl	8.00 g
KCl	0.20 g
Na <sub>2</sub> HPO <sub>4</sub> (anhydrous)	0.91 g
KH <sub>2</sub> PO <sub>4</sub>	0.12 g

Dissolve the salts in 600–800 ml distilled H<sub>2</sub>O. Make up to 1000 ml with distilled H<sub>2</sub>O and autoclave at 10 psi (70 kPa) for 15 minutes. This gives a **working solution of incomplete PBS** (i.e. no calcium or magnesium ions present).

#### 3) Solution B

MgCl <sub>2</sub> ·6H <sub>2</sub> O	0.10 g
--------------------------------------	--------

Dissolve in 100 ml distilled H<sub>2</sub>O. Autoclave at 10 psi (70 kPa) for 15 minutes.

#### 4) Solution C

CaCl <sub>2</sub>	0.10 g
-------------------	--------

Dissolve in 100 ml distilled H<sub>2</sub>O. Autoclave at 10 psi (70 kPa) for 15 minutes.

#### 5) Working solution of complete PBS

The working solution of complete PBS contains 0.11 M NaCl. Add 1 part of Solution B and 1 part of Solution C to 8 parts of Solution A.

Alternatively, use commercially prepared tablets or powder following the manufacturer's instructions for reconstitution and sterilization.

#### 6) PBS with antibiotics

Dissolve 1x10<sup>6</sup> units crystalline penicillin G and 1g streptomycin sulfate in 100 ml sterile complete PBS, distribute into 5 ml volumes and store at -20°C. For use, add 5 ml of this stock solution to 500 ml complete PBS to give a final concentration of 100 units / ml penicillin and 100µg / ml streptomycin. Store refrigerated at 4 to 8°C for up to one week.

---

## 7) Other antibiotics

Penicillin and streptomycin are the antibiotics most commonly used in cell and routine virus culture work; they are also the least expensive. When used at the correct concentration and in conjunction with chloroform extraction, penicillin and streptomycin are usually capable of limiting the level of contaminating bacteria in the faecal suspensions. Occasionally, however, use of penicillin and streptomycin does not provide adequate protection and alternative antibiotics can be tried. Gentamicin is more expensive than penicillin and streptomycin, but it is inhibitory to a wider range of bacteria and it is autoclavable. Gentamicin should be used at a final concentration of 50µg/ml. Mycostatin may be used at 25 units/ml to counteract fungal and yeast contaminants; however, it is only fungistatic and not fungicidal, is rapidly inactivated at 36°C (usual cell culture incubation temperature) and some batches are slightly cytotoxic.

---

# 7. Isolation and identification of polioviruses

## 7.1 Recommended cell lines for the isolation of polioviruses

Polioviruses grow readily in a wide variety of continuous human and primate cell lines. All specimens suspected of containing polioviruses should be inoculated into the following two cell lines:

- L20B cells, a mouse cell line (L-cells), genetically engineered to express the human poliovirus receptor. (NB. Some laboratories may need to declare L20B cells as genetically modified materials to local authorities in order to comply with national regulations.)
- RD cells, derived from a human rhabdomyosarcoma.

The selection of only two cell lines for the laboratory diagnosis of poliomyelitis permits the standardization of techniques and the comparability of results among various virus laboratories.

Susceptibility of these cell lines to enteroviruses is as follows:

- **L20B:** susceptible to polioviruses, which produce a characteristic enterovirus cytopathic effect (CPE). These cells are highly selective for polioviruses. Some non-polioviruses that are capable of producing CPE in L cells (e.g. adenoviruses and reoviruses) are also likely to produce CPE in L20B cells, but their CPE is usually noticeably different from polio-virus induced CPE. A small number of non-polio enteroviruses (e.g. Coxsackie A viruses) may also grow in L20B cells (occasionally only after prior growth in another cell line) and they can produce characteristic enterovirus CPE.
- **RD:** highly susceptible to polioviruses, many ECHO viruses and some other enteroviruses, all of which produce a characteristic enterovirus CPE.

This combination of cell lines provides great sensitivity and specificity in detecting polioviruses while maintaining the ability to detect some enteroviruses as an assurance of good technique.

A third cell line, HEp-2 (Cincinnati), was formerly recommended for routine use in the network, but has now been replaced by L20B. Polio and coxsackie B viruses grow on HEp-2 (C) producing CPE. Omission of this cell line may result in a decrease in the rate of isolation of non-polio enteroviruses, especially when coxsackie B viruses are circulating in the community. However this disadvantage



---

must be offset against the advantages of greater efficiency of detecting polioviruses when using a combination of L20B and RD, especially from samples containing mixtures of other enteroviruses.

**Good laboratory practice:** It is important to monitor the sensitivity of the RD and L20B cell lines to polioviruses by periodically titrating reference vaccine poliovirus strains. Care must also be taken to keep cell lines free from Mycoplasma contamination by discarding cells found to be contaminated, and by replacing working cells every 15 passages or three months with new material from the laboratory working cell bank stored in liquid nitrogen.

## 7.2 Isolation of polio and other enteroviruses

Have available the following items:

- tube cultures of L20B and RD cells;
- maintenance medium;
- 1 ml and 5 ml plastic disposable pipettes.

Do the following:

- Microscopically examine recently monolayered cultures to be sure that the cells are healthy. A suitable monolayer would be one formed within 2–3 days of seeding.
- Remove the growth medium and replace with 1 ml maintenance medium.
- Label two tubes of RD and two of L20B for each specimen to be inoculated (specimen number, date, passage number).
- Label one tube of each cell type as a negative control.

**Note: Both cell lines must be inoculated at the same time.**

- Inoculate each tube with 0.2 ml of specimen extract and incubate in the stationary sloped (5°) position at 36°C. L20B cells will not survive being rotated and it is unnecessary for poliovirus isolation.
- Examine cultures daily, using a standard or inverted microscope, for the appearance of CPE.
- Record all observations of inoculated and control cultures for at least one week, recording CPE (1+ to 4+) to indicate the percentage of cells affected (1+ to up to 25%; 2+ to 25 to 50%; 3+ to 50 to 5% and 4+ to 75 to 100%), toxicity<sup>1</sup>, degeneration or contamination<sup>2</sup>.

---

<sup>1</sup> **Toxicity:** If cell cultures show rapid degeneration within one or two days of inoculation this may be due to non-specific toxicity of the specimen. These tubes should be frozen at –20°C, thawed, and 0.2 ml volumes passaged (i.e. now second passage) in cultures of the same cell type. If toxic appearances recur, return to the original specimen extract and dilute this in PBS at 1/10 and re-inoculate cultures as described above. This should be considered as the first passage.

<sup>2</sup> **Microbial contamination:** Contamination of the medium and cell death resulting from bacterial contamination makes detection of viral CPE uncertain or impossible. Return to the original specimen extract, **re-treat with chloroform** and inoculate fresh cell cultures as described above.

- 
- If characteristic enterovirus CPE appears, i.e. rounded, refractile cells detaching from the surface of the tube, record, allow to develop until at least 75% of the cells are affected (3+ CPE), then store at -20°C for a second passage in a tube containing 2 ml of medium. Second passage material can be pooled for typing and ITD.
  - If no CPE appears after seven days, perform a blind passage<sup>3</sup> and continue examination for a further seven days. (NB. Contents of replicate cell cultures from an individual case should not be pooled for passage, i.e. individual cell cultures should be passaged separately).
  - Negative cultures should be examined for a total of at least 14 days before being discarded (*see Figure 7.1*).
  - Any culture positive in RD cells but negative after 14 days in L20B cells should be re-passaged in L20B cells<sup>4</sup> and examined for seven days to exclude the possibility that they are polioviruses (*see Figure 7.1*).
  - Some stool samples contain viruses other than enteroviruses that may be able to produce CPE in L20B cells (some reoviruses and adenoviruses for example). In many cases the CPE produced is clearly distinctive from enterovirus-characteristic CPE. The presence of non-enterovirus CPE causing agents in the samples must be recorded as such. Some non-polio enteroviruses may also produce CPE in L cells and therefore produce CPE in L20B cells. Poliovirus typing should still be attempted on these isolates to exclude the possibility that they contain poliovirus. If indeterminate or non-interpretable results are obtained on typing, the isolate must be sent to the Regional Reference Laboratory (RRL) for analysis.

---

<sup>3</sup> **Blind passage:** As sometimes happens with continuous cell lines, at the end of one week “ageing” or degeneration of cultures becomes evident also in the inoculated control cultures. Freeze the tubes at -20°C, thaw and passage 0.2 ml of culture fluid to tubes containing fresh monolayers of the same cell type and examine daily for a further 7–10 days. If cultures show no CPE by this stage, the result is regarded as negative.

<sup>4</sup> **Re-passage in L20B cells:** It is now known that a small percentage of poliovirus isolates do not to grow well in L20B cells on first passage, and may not produce recognizable CPE. They do, however, grow in RD cells, and on passage in L20B cells these isolates produce recognizable CPE. It is important, therefore, that in order not to miss any poliovirus all cultures positive in RD cells but negative in L20B cells should be passaged in L20B cells by inoculating 0.2 ml of RD or RD2 passage isolate in L20B cells (*see Figure 7.1*).

Figure 7.1: Flow-chart for poliovirus isolation in RD and L20B cells

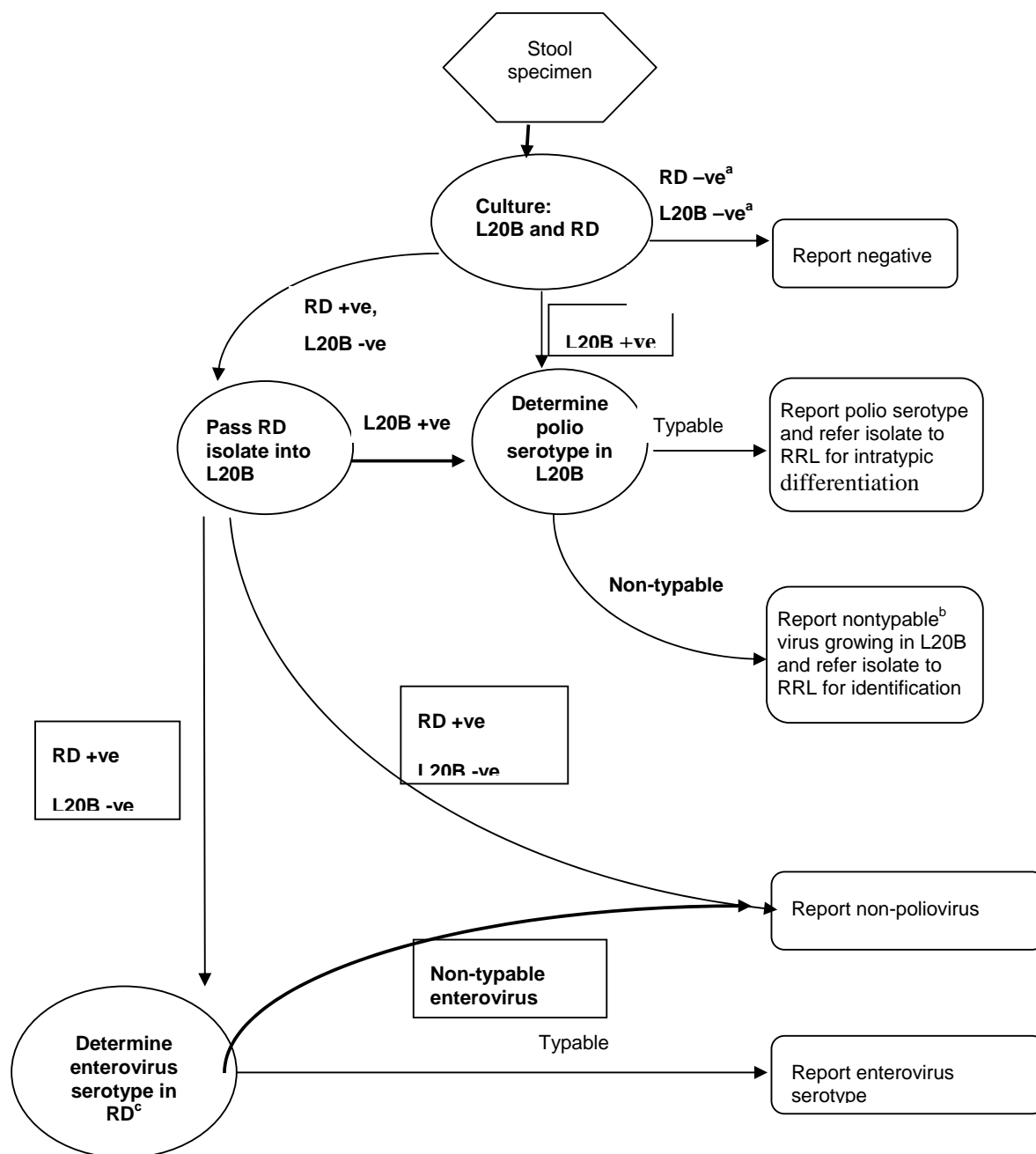

<sup>a</sup> Passaged two times for a minimum of 14 days in total.

<sup>b</sup> Inform regional laboratory coordinator and national programme if nontypable isolate obtained in L20B cells from samples from non-endemic or recently endemic country.

<sup>c</sup> Type non-polio enteroviruses only at request of EPI programme.

---

**Good laboratory practice:** The utmost care should be taken to avoid viral cross-contamination of cultures during inoculation, passage procedures. Medium should never be decanted from inoculated tubes; medium should be removed with a pipette, and pipettes changed between each procedure. DO NOT use micropipettors except if they are used with aerosol resistant tips (ARTs). Care should be taken to avoid aerosols created by vigorous pipetting, and spilled droplets must be immediately cleaned with disinfectant.

### 7.2.1 *Supplementary tests for poliovirus isolation*

In the final stages of the programme, when polio has become a focal or sporadic disease, concern may increase about possibly missing wild polioviruses in specimens from acute flaccid paralysis (AFP) cases. Specimens from cases of high concern may be subjected to additional testing using one or more of the following methods.

**Additional passage:** As described above, material from an inoculated culture is transferred to a tube of freshly monolayered cells after freezing and thawing to release any virus present. The use of young, healthy cells may permit the development of recognizable CPE not apparent in the original culture, particularly in case toxicity and contamination were present. No more than one additional passage (three passages in all) should be done, since each manipulation increases the risk of viral cross contamination and the finding of false positives.

**Adsorption of specimen onto a monolayer:** Instead of transferring the treated specimen extract directly into cultures containing maintenance medium, the cell growth medium is first removed, the cell layer rinsed with sterile PBS and 0.2 ml of specimen extract allowed to adsorb to the cell layer for one hour at room temperature with gentle rocking or occasional rolling of the tubes to distribute the inoculum and prevent drying of peripheral cells. One ml of maintenance medium is then added to each tube. Use of this method may result in the detection of marginal concentrations of virus, reduces the effect of toxic specimens, and has been shown to speed the appearance of CPE by at least one day. Against this benefit must be weighed the possibility of viral (and possibly bacterial) cross-contamination of tubes due to the extra opening/closing of cell cultures during this procedure. **Due to the high risk of cross-contamination when using high titred samples, this method must not be used for passaging or inoculation of isolates.**

### 7.3 Identification of poliovirus isolates

For the identification of poliovirus isolates, samples of diluted isolate are mixed with equal volumes of a selected set of polyclonal antisera made in animals against poliovirus types 1, 2 and 3. These antisera have been developed by the National Institute of Public Health and the Environment (RIVM), Bilthoven, The Netherlands, and are supplied free of charge to WHO Polio Laboratory Network laboratories by WHO. Using the micro-neutralization (microtitre plate) technique, the serum/virus mixtures are incubated for one hour at 36°C to allow the antibodies to bind to the virus. Subsequently, suspensions of cells are added to the microtitre plates which are examined daily for the presence of CPE. The antiserum that prevents the development of CPE indicates the identity of the virus.

---

### 7.3.1 Preparation of RIVM poliovirus typing antisera

One of the primary functions of the virus laboratory participating in the poliomyelitis eradication initiative is to identify polioviruses isolated from clinical specimens. First attempts at virus isolate identification should concentrate on this aspect alone, using monospecific polyclonal poliovirus antisera to types 1, 2 and 3 combined as antiserum pools. Monospecific antisera can be used for confirmation of serotype.

The rabbit antisera listed below are available through VAM/IVB/WHO, Geneva, with homologous titres of:

- 40 960 to polio type 1
- 163 840 to polio type 2, and
- 40 960 to polio type 3

These reagents are distributed by WHO solely for use in the poliomyelitis eradication programme. Global stocks are limited, so it is requested that they be used appropriately.

Each vial of RIVM poliovirus typing antiserum contains 0.5 ml rabbit antiserum. This should be diluted in 63.5 ml of maintenance medium to give 64 ml at a working dilution of 1:128.

Pools should be prepared as in Table 7.1.

**Table 7.1: Preparation of RIVM typing reagents**

Pool	Polio 1, 2, 3	Polio 1, 2	Polio 1, 3	Polio 2, 3
Volume of each 1/128 dilution antiserum required				
Polio 1	10 ml	15 ml	15 ml	/
Polio 2	10 ml	15 ml	/	15 ml
Polio 3	10 ml	/	15 ml	15 ml
Total volume	30 ml	30 ml	30 ml	30 ml

Aliquot the pools into clearly labelled screw-capped cryovials in 1 ml volumes and store at -20°C. The remaining monovalent antisera should be stored in cryovials at -20°C and used for confirmation of individual separated isolates or for making further pools. **For each 30 ml pool there should be enough antisera for 150 tests.**

**Good laboratory practice:** Each time a batch of new pools is prepared, it is essential that their ability to correctly identify poliovirus isolates be confirmed by testing each pool against preparations of vaccine poliovirus types 1, 2 and 3.

---

### 7.3.2 Neutralization test for identification of polioviruses

High-titred polyclonal antisera are used and are mixed with approximately 100 CCID<sub>50</sub> of the unknown virus isolate. A suspension of virus from a tube showing 3+ to 4+ CPE in healthy cell cultures is expected to contain approximately 10<sup>5</sup>–10<sup>6</sup> CCID<sub>50</sub>/ 50 µl. Dilutions of 10<sup>-3</sup> and 10<sup>-4</sup> have been selected for use in this test in the interest of saving time and material required for the prior titration of each isolate. A back titration of the isolate is included in each test to allow calculation of the titre of virus actually present in that test.

If virus isolates are obtained in both RD and L20B cell cultures, identification of the L20B isolate should be performed first. The most important programmatic result is obtained most rapidly in this way. If poliovirus typing of a L20B isolate is not conclusive, the RD isolate should be used for poliovirus typing. The L20B isolate should be referred to the RRL for further characterization.

#### (i) Poliovirus neutralization procedure

Have available the following items:

- sterile 96-well flat bottomed dell culture microtitre plates with lids;
- sterile, non-toxic plate sealers (if no CO<sub>2</sub> incubator will be used);
- 5 ml sterile tubes for dilution;
- 1 ml and 2 ml disposable plastic pipettes;
- sterile 50 µl droppers or pipettors with aerosol resistant tips (ARTs);
- flask of healthy cells of the type in which the virus was confirmed (usually L20B);
- polio antiserum pools;
- maintenance medium.

Do the following:

- Label the edge of the microtitre plate as indicated in Figure 7.2 (for two unknown virus isolates).
- Distribute 50 µl of each of the four antiserum pools in columns 1 to 8, rows A to D, using a different dropper/pipette tip for each pool.
- Add 50 µl medium to virus control wells, A9 to D10.
- Add 50 µl medium to back titration wells E1 to H10.
- Add 100 µl medium to cell control wells G11 to H12 and cover plate.
- Label dilution tubes 10<sup>-1</sup> to 10<sup>-7</sup>, marking each set with specimen number (Figure 7.3).
- Dispense 0.9 ml medium to tubes 1–2 and 5–7, and 1.8 ml to tubes 3 and 4.
- Add 0.1 ml virus to first tube (=10<sup>-1</sup> dilution) using sterile pipette or pipettor with ART tip.
- Take another pipette/pipette tip, mix thoroughly but gently to avoid aerosols.
- Transfer 0.1 ml to the second tube and discard pipette/pipette tip.

Figure 7.2: Plate set-up for poliovirus identification test

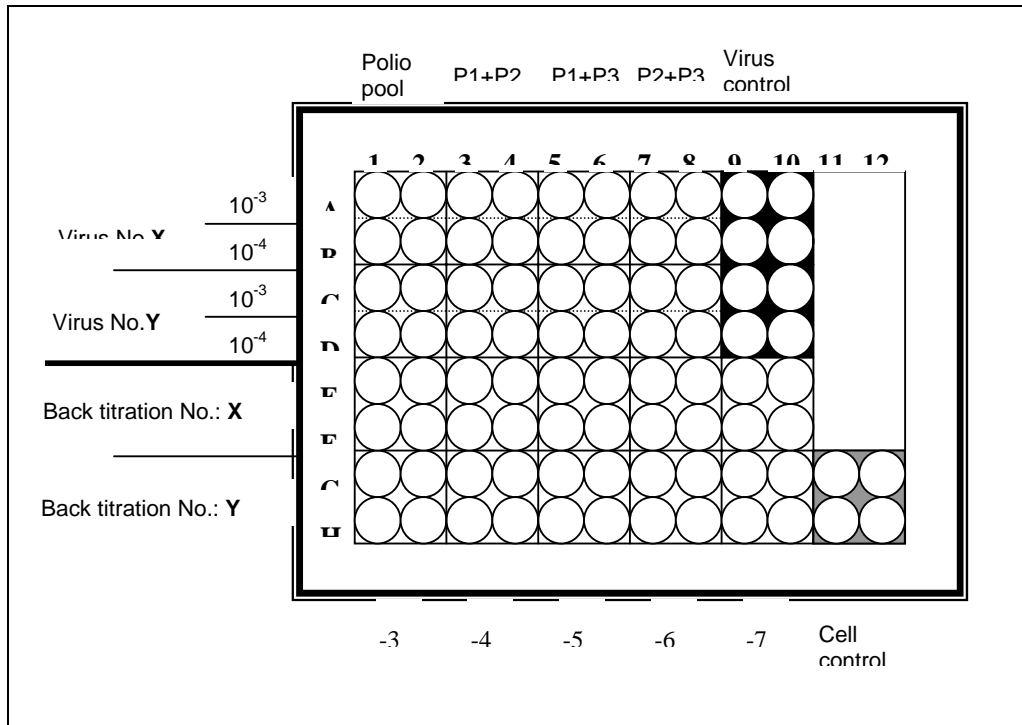
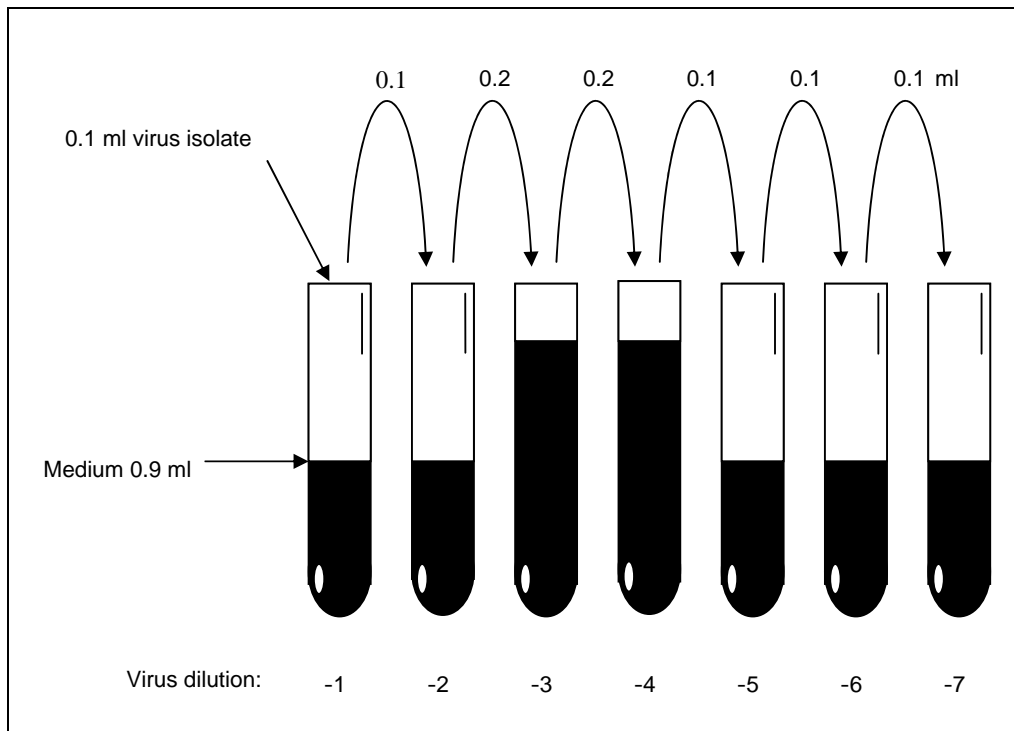

Figure 7.3: Titration of virus isolates



- 
- Repeat dilution steps, transferring 0.2 ml to tubes 3 and 4 (*Figure 7.3*). Add virus to the back titration wells of the microplate beginning at the  $10^{-7}$  dilution in columns 9 and 10, rows E and F.
  - The same dropper/pipettor ART tip may be used for one isolate, working from highest to lowest dilution,  $10^{-7}$  to  $10^{-3}$ .
  - Add 50  $\mu$ l virus to the test wells as indicated:  $10^{-3}$  dilution of isolate 1 to wells A1–A10,  $10^{-4}$  dilution to wells B1–B10 etc.
  - Repeat the last two steps for the second isolate in rows G and H for the back titration, in wells C1–C10 for the  $10^{-3}$  dilution of isolate 2, and in wells D1–D10 for the  $10^{-4}$  dilution of isolate 2.
  - Cover the plate with the lid and incubate between one and three hours at 36°C.
  - During this incubation period, trypsinize cells and prepare a suspension of approximately  $1.5 \times 10^5$  cells per ml, calculating at least 10 ml per plate (*see Section 4*).
  - Distribute 100  $\mu$ l of cell suspension into test and control wells.
  - If not using a CO<sub>2</sub> incubator, seal plate with non-toxic sealers.
  - Incubate at 36°C.
  - Examine and record daily, using an inverted microscope, for development of CPE.
  - Continue observation and recording until 24 hours after the virus control wells show 100% CPE (usually 3–5 days).

**Good laboratory practice:** When making dilutions remember to change pipettes or pipette tips after addition of virus to avoid carry-over of virus on the outside of the pipette/tip.

### *(ii) Interpretation of results*

Cell control wells should have a complete monolayer of cells. Virus control wells should show complete CPE. The back titration should confirm that the amount of virus used in the test for one of the dilutions was within the range 32–320 CCID<sub>50</sub> (i.e. virus titre between  $10^{1.5}$  and  $10^{2.5}/50 \mu$ l corresponding to  $10^{4.5}$  to  $10^{6.5}$  in the original isolate). The test result should be read from the dilution that corresponds to the correct virus titre for the test. If the virus titre in the test is not within the acceptable range, the test should be repeated with the dilutions adjusted (either higher or lower, as appropriate) to contain the correct amount of virus.

The antiserum pools that prevent the development of CPE indicate the identity of the virus isolate or mixture of viruses. Failure of a virus to replicate in the presence of a pool of antisera is due to the neutralization of infectivity by one of the antisera present in the pool.

Figure 7.4 shows the typical lay-out of a test plate with interpretation of results.



Figure 7.4: Identification of poliovirus isolates using the microtechnique

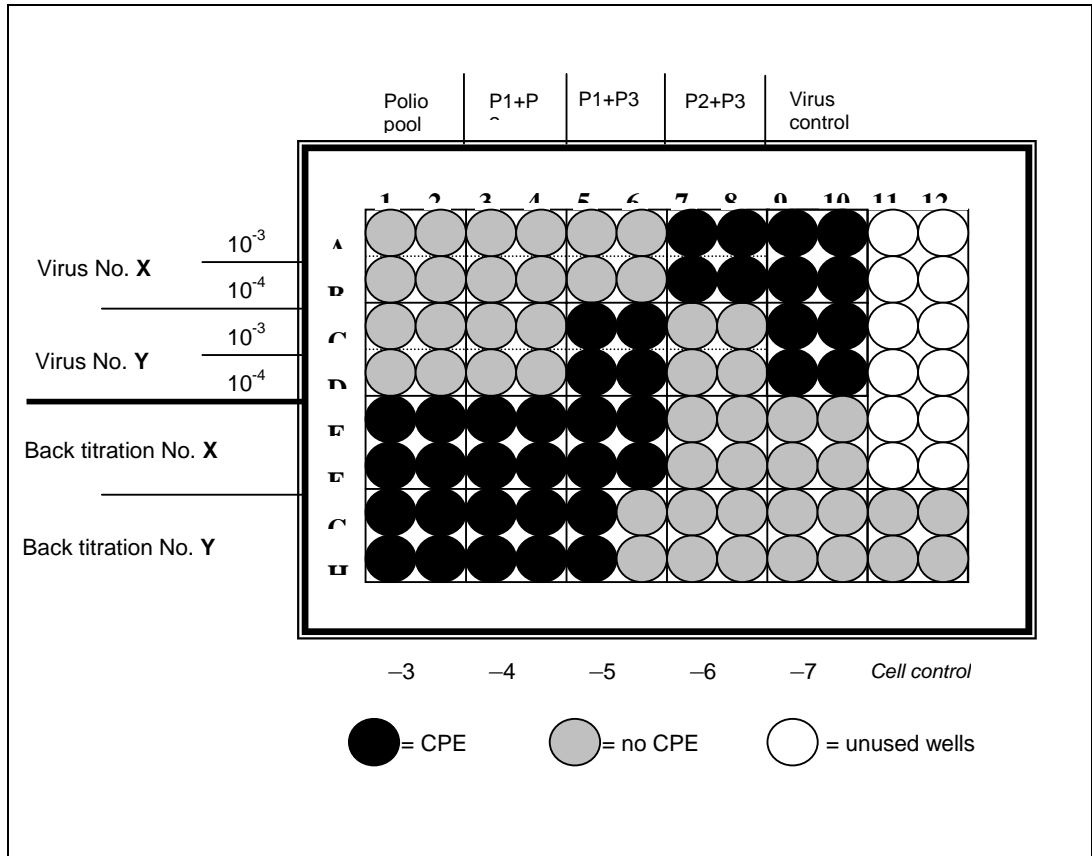

Virus titre of isolate X =  $10^{5.5}$  CCID<sub>50</sub> / 50 µl;

Test at 10<sup>-3</sup>, virus dosage = 320 (10<sup>2.5</sup>) CCID<sub>50</sub>

Test at 10<sup>-4</sup>, virus dosage = 32 (10<sup>1.5</sup>) CCID<sub>50</sub>

Isolate neutralized by Polio pools 1+2+3; 1+2; 1+3

Poliovirus type 1

Virus titre of isolate Y =  $10^5$  CCID<sub>50</sub> / 50 µl;

Test at 10<sup>-3</sup>, virus dosage = 100 (10<sup>2.0</sup>) CCID<sub>50</sub>

Test at 10<sup>-4</sup>, virus dosage = 10 (10<sup>1.0</sup>) CCID<sub>50</sub>

Isolate neutralized by Polio pools 1+2+3; 1+2; 2+3

Poliovirus type 2

Cell controls = Normal growth

**Table 7.2: Interpretation of virus neutralization patterns in the poliovirus identification test**

Pool P1+P2+P3	Pool P1+P2	Pool P1+P3	Pool P2+P3	Virus identification
0	0	0	+	Poliovirus type 1
0	0	+	0	Poliovirus type 2
0	+	0	0	Poliovirus type 3
0	0	+	+	Mixture of poliovirus types 1 & 2
0	+	0	+	Mixture of poliovirus types 1 & 3
0	+	+	0	Mixture of poliovirus types 2 & 3
0	+	+	+	Mixture of all three poliovirus types
+	+	+	+	No poliovirus or mixture of poliovirus with other enterovirus
+ = CPE		0 = no CPE		

**Note:** Where CPE occurs in test wells containing all combinations of polio antisera (last row of figure) there are two possibilities. The first is that the virus is not polio, but some other virus (e.g. an enterovirus or adenovirus). The second is that there may be a mixture of polio and another virus. Since the detection of poliovirus is of prime importance, the L20B isolate should be referred to the RRL as soon as possible for further characterization.

In Table 7.2 all possible combinations of CPE and NO CPE, which may be observed in wells containing the various polio antiserum pools, are tabulated with the appropriate interpretation. “Breakthrough” of virus occurring after the final result may be due to too high a dose of virus used in the test, or to the presence of a second virus in a lower concentration. It is therefore recommended that all mixed poliovirus isolates be confirmed using individual antisera. It is not necessary to perform a complete typing test using antisera pools.

*(iii) Protocol for confirmation test for virus typing*

- 1) Collect the virus from the appropriate wells of the plate used for polio typing.
- 2) When the plate is covered with a plate sealer do not remove the cover as this may cause cross-contamination. Wipe the plate sealer with 70% alcohol and puncture the covering of the wells involved with a hot glass pipette or sterile needle. Never try to push a glass pipette through the plastic cover, as the pipette may break and cause serious injuries.
- 3) Make a 1 in 10 dilution of the virus.
- 4) Prepare a plate containing, for each virus to be tested, two wells with 50 µl anti P1 serum, two wells with 50 µl anti P2 serum, two wells with 50 µl anti P3 serum, and two wells with 50 µl growth medium, that serve as virus controls.
- 5) Add 50 µl of the diluted virus to all 8 wells.
- 6) After 1hr incubation at 37°C, add 100 µl of cells.
- 7) Seal the plate, incubate 24–48 hrs at 36°C and record CPE.

---

*(iv) Referral of isolates*

It is essential that the polio eradication programme be aware of wild poliovirus and VDPV isolations as soon as possible. All poliovirus isolates from AFP, contacts and suspected polio cases must be forwarded without delay to the appropriate Regional Reference Laboratory (for details see Section 10, Specimen and Isolate Transport). If a mixture of polioviruses is detected, then both the mixture and the separated isolates should be sent to the Regional Reference Laboratory for confirmation and ITD. If a Laboratory experiences difficulties in separating or fully identifying viruses then the isolate and an aliquot of the original sample should be sent without delay to the appropriate Regional Reference or Specialized Reference Laboratory.

#### **7.4 Identification of non-poliovirus enteroviruses**

Non-polio enteroviruses (NPEVs) circulate in all populations and infection can be associated with a vast range of presentations, from asymptomatic to acute flaccid paralysis resembling polio. In general, depending on local environment and climate, 5 to 25% of stool specimens collected from healthy children can be expected to contain NPEVs. For the purposes of polio eradication it is not necessary to characterize these viruses and they can be reported simply as NPEVs. Furthermore, with the introduction and use of the L20B cell line it is no longer necessary to neutralize enterovirus cultures to exclude the possibility of a non-polio enterovirus isolate masking the presence of poliovirus in mixed cultures. However, many laboratories do wish to characterize enterovirus isolates to obtain epidemiological information. Following the recommended flowchart for isolation and typing of polioviruses and enteroviruses (Figure 7.1), enterovirus typing can be performed on the RD culture of a clinical sample.

##### **1) Antisera**

Antisera have been raised in animals against many echoviruses and coxsackieviruses. Because the large number of viruses makes it impractical to perform individual neutralization tests, these have been pooled in an overlapping scheme which allows many viruses to be identified using as few as nine tests. Interpretation of the results is done with the assistance of a list of the neutralization patterns of individual viruses. Pooled horse antisera against the most frequently isolated ECHO and Coxsackieviruses have been prepared at the National Institute of Public Health and the Environment (RIVM), Bilthoven, The Netherlands, and are supplied free of charge to WHO Polio Laboratory Network laboratories by WHO (IVB/VAM) Geneva.

Each box of RIVM enterovirus typing antisera contains anti-enterovirus pools A, B, C, D, E, F and G, an anti-Coxsackie B virus pool and a trivalent anti-poliovirus pool. These pools must be diluted before use.

The recommended dilution for all pools is 1 in 20: 0.5 ml of each pool is added to 9.5 ml of the medium specified on the insert.

Aliquot pools into clearly labelled cryovials in 1 ml volumes and store at -20°C.

---

To test each virus, two dilutions in single wells are used.

For each pool A to G (10 ml), there should be enough antisera for 100 tests.

## 2) Neutralization test for identification of enteroviruses

Have available the following items:

- Flat-bottomed cell culture microtitre plate with cover;
- non-toxic plate sealers (if non-CO<sub>2</sub> incubator will be used);
- 5 ml sterile tubes for dilution;
- 1 ml and 2 ml pipettes;
- sterile 50 µl droppers or pipettors with aerosol resistant tips (ARTs);
- flask of healthy RD cells;
- enterovirus serum pools at use dilution;
- maintenance medium.

Each unknown virus is tested in duplicate against a trivalent pooled polio antiserum (PP), a coxsackievirus B1-6 pool (CP), and seven pools against coxsackievirus A9 and 20 echoviruses (A–G). Non-polioviruses that fail to be identified using these antisera may be in an aggregated form which interferes with the complete neutralization by specific antisera. Isolates can be retested after emulsification with chloroform (approximately 10% by volume) and separation of the supernatant. Freezing of the chloroform-treated isolates can result in re-aggregation of the virus, so chloroform treatment should be followed by typing prior to freezing the isolate.

Do the following:

- Label the edge of the microtitre plate as indicated in Figure 7.5.
- Add 50 µl of antisera to the appropriate wells in columns 1–9.
- Add 50 µl medium to virus control wells in column 10 rows A to D.
- Add 100 µl medium to cell control wells in columns 11 and 12 rows A to D.
- Prepare 10<sup>-2</sup> dilution of virus (it may be desirable to determine the virus titre and adjust the dilutions as needed).
- Add 50 µl virus to all wells in columns 1 to 10 of rows A to D for sample X and rows C and D for sample Y.
- Perform a back titration of virus X in rows E and F and of virus Y in rows G and H.
- Cover the plate with the lid and incubate for one hour at 36°C.
- During this incubation period, trypsinize RD cells and prepare a suspension of approximately 1.5 x 10<sup>5</sup> cells per ml, calculating at least 10 ml per plate.
- Distribute 100 µl of cell suspension into all wells.
- Cover the plate with a non-toxic sealer and incubate at 36°C.
- Examine daily, using an inverted microscope, and record CPE.



---

## 8. Intratypic differentiation of polio viruses

Isolation and identification of polioviruses from acute flaccid paralysis (AFP) cases is the first step in detecting the circulation of wild poliovirus and vaccine-derived polio virus (VDPV) in the community. Vaccine strains circulate widely during and after immunization campaigns and may be found in healthy and symptomatic children. It is therefore necessary to determine whether poliovirus isolates are wild or vaccine-derived.

Five methods for intratypic differentiation (ITD) are recommended for use in Regional Reference laboratories of the Network, and three of these are currently supported through the Network. They are:

- the ELISA method using cross-adsorbed antisera (developed by RIVM);
- the Probe hybridization method developed by CDC;
- the diagnostic PCR method developed by CDC.

The other two, the PCR-RFLP developed by the Pasteur Institute, Paris and NIID Tokyo and the monoclonal antibody assay developed by the Pasteur Institute, Paris and NIBSC, Potters Bar, are accepted methods but are not currently supported by the Network.

### 8.1 ELISA method for intratypic differentiation

**The RIVM ELISA for intratypic differentiation should only be performed on single serotype isolates.** In case an isolate contains a mixture of 2 or 3 serotypes of polioviruses, the various components must be separated from each other by growing the isolate in the presence of the appropriate antisera.

#### 8.1.1 *Test principle*

Wells of microtitre plates or strips coated with bovine IgG antibodies to poliovirus types 1, 2 and 3 are incubated with the identified and typed poliovirus strain to be tested. Incubation is then carried out with the type-specific, cross-adsorbed rabbit antisera. After washing off any unbound rabbit sera peroxidase-labelled anti-rabbit IgG antibody is added to detect bound rabbit sera. RIVM supplies a kit containing essential reagents to carry out the ELISA method which is obtainable through WHO.

---

### 8.1.2 *Kit components*

The kit supplied by RIVM contains the following:

- 1) **Bovine serum:** IgG fraction of type-specific bovine antiserum to all three poliovirus types.
- 2) **Rabbit serum:** type-specific rabbit antiserum to poliovirus.
- 3) **Adsorbed rabbit serum:** type-specific, cross-adsorbed rabbit antiserum. Poliovirus type 1, NSL and SL; Poliovirus type 2, NSL and SL; Poliovirus type 3, NSL and SL. Antisera have been heat inactivated at 56°C for 30 minutes to render them non-infectious.
- 4) **Prototype virus:** polio prototype strains, non-infectious types 1, 2, and 3, non-Sabin-like (NSL). Polio prototype strains should be stored at 4°C and never frozen.

**Also required but not supplied are the following:**

- **Carbonate buffer, pH 9.5:** Dissolve 1.27 g Na<sub>2</sub>CO<sub>3</sub> and 2.34 g NaHCO<sub>3</sub> in 1 litre distilled water. Filter through a 0.22 µm filter. This solution can be stored for one year at 4°C.
- **Sodium acetate buffer, pH 5.5:** Dissolve 9 g sodium acetate in 900 ml distilled water. Adjust pH to 5.5 with 10% acetic acid. Adjust volume to 1 l.
- **Washing buffer:** Add 0.5 ml Tween 20 (Polyoxyethylene Sorbitane Monolaurate) to 1 litre PBS.
- **Dilution buffer:** Dilution buffer = washing buffer + 5% calf serum. Dilution buffer must be prepared freshly before each experiment.
- **Stop solution:** Sulfuric acid, 2N.
- **Conjugate:** Goat anti-rabbit IgG, Horseradish peroxidase-labelled.
- **Substrate solution:** TMB: 3,3',5,5'-Tetramethyl benzidine. Dissolve 60 mg TMB in 10 ml DMSO.
- **Urea peroxide:** Dissolve 1 tablet (Organon Technika) in 10 ml distilled water. Add 0.2 ml TMB solution and 0.1 ml UP solution to 12 ml 0.11 M sodium acetate, pH = 5.5. The substrate solution has to be prepared freshly for each experiment and has to be stored in the dark.

Alternatively there are commercially available one-component substrate solutions. (e.g. KPL: Kirkegaard & Perry Laboratories, catalogue number 50-76-18). Follow the exact instructions as given by the manufacturer.

---

**Good laboratory practice:** To avoid problems using the ELISA assay observe the following:

- Do not perform the test in the presence of reactive vapours (i.e. from acids, alkalis or aldehydes), or dust, since this may affect the enzymatic activity of the conjugate.
- Use only thoroughly cleaned glassware, particularly for preparing substrate solutions.
- All pipetting steps should be performed with the utmost care and accuracy.
- To avoid contamination, do not touch the top of the plates or strips with your fingers and do not touch the edges of the wells with the pipette tips when adding conjugate or substrate.
- Check for air bubbles after all pipetting steps; if present, remove by gentle tapping.
- Check the efficacy of your washing procedure, especially after the incubation with the conjugate.
- Solutions of TMB and/or peroxide should not come into contact with metals or metal ions, since this may give rise to unwanted colour formation.
- If wells cannot be filled immediately after washing, the plates /strips may be placed upside down on wet absorbent material for no more than 15 minutes.
- Be extremely cautious with preparation and use of 2N H<sub>2</sub>SO<sub>4</sub>. Acid should always be added to water, never the reverse. Wear protective clothing and eyewear and prepare well in advance of use, due to heat development during dilution.

### **8.1.3 Test procedure**

Have available the following items:

- 96-well immunological microtitre plates or microtitration strips
- adjustable pipettors
- 8-channel multichannel pipettor 50–200 µl or equivalent system
- disposable pipette tips
- ELISA plate washer
- ELISA reader
- incubator at 36°C
- refrigerator at 4–8°C.

Substrate and conjugate can be tested separately before running an actual test.

The principle, based on the use of an 8-well plate washer, is schematically shown in Figure 8.1. For laboratories possessing a 12-well washer the plate configuration should be rotated through 90°.



**Figure 8.1: Plate set-up for ELISA poliovirus intratypic differentiation test**

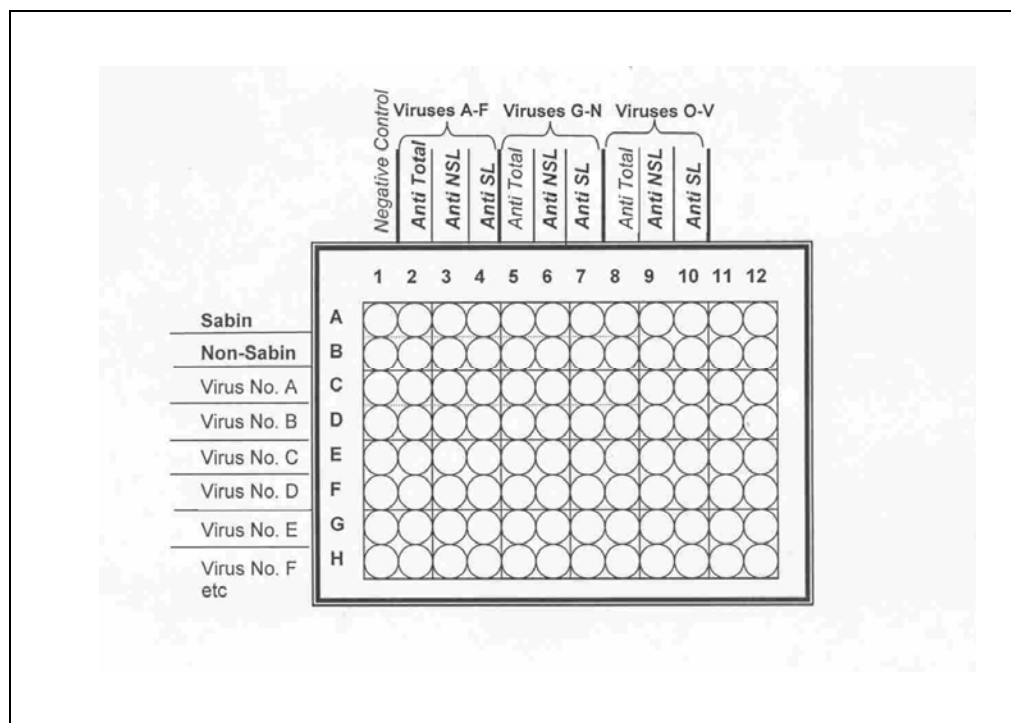

**(i) Preparation**

- 1) Unwrap a sufficient number of plates or strips to accommodate all the samples and controls to be tested. For each strain at least 3 wells are needed: one each for reaction with the type-specific antiserum, the NSL and SL-specific cross-adsorbed antisera.
- 2) Number your strips and use corresponding numbers on the recording sheet.

**(ii) Coating**

- 1) Add to each well 0.1 ml of the bovine anti-poliovirus serum diluted 1:500 (or according to kit instructions) in pH 9.5 0.04 M carbonate buffer.

**(iii) Washing and blocking**

- 1) Wash the plates/strips four times with washing buffer. Use 0.3 ml per well each time. This may be done with an automatic washer or manually using a multi-channel pipette.
- 2) Dry the top of the plates/strips with an absorbent tissue.
- 3) Add 0.1 ml of PBS + 5% calf serum to each well and incubate for one hour at 37°C. This avoids non-specific binding of poliovirus antigen, antiserum or conjugate to the solid phase.

---

*(iv) Antigen*

- 1) Wash plate four times as above.
- 2) Perform this step in a BSC as live (possibly wild) poliovirus is to be added to the plate. Add 0.1 ml undiluted virus strain to each of 3 wells (A2 to A4), (B2 to B4) etc. (or 6 wells if test is being done in duplicate). Repeat for each test virus.
- 3) Include positive and negative controls on each plate.
- 4) Add 0.1 ml dilution buffer to the wells of the first strip or column to serve as controls (A1 – H1).
- 5) Incubate for two hours at 37°C. Be sure that the plate is well covered during this incubation to prevent contamination of incubators with aerosols or droplets of wild poliovirus.

*(v) Antibody*

- 1) Wash plate four times, as above. Perform this step in a BSC and treat washes as infectious wastes as live (possibly wild) poliovirus is being removed from the plate.
- 2) Dilute the cross-adsorbed type-specific rabbit antisera in diluent during the washing procedure. The exact dilution of the cross-adsorbed sera has been determined in advance for each lot of antiserum.
- 3) Add 0.1 ml of the diluted type-specific rabbit antiserum, the NSL-specific antiserum and the SL-specific antiserum to the appropriate wells (type-specific, wells A2 – H2; NSL, wells A3 – H3; SL, wells A4 – H4). Add 0.1 ml diluent to the control wells (A1-H1). Incubate for one hour at 37°C.

*(vi) Conjugate*

- 1) Wash plate four times, as above.
- 2) Add 0.1 ml of conjugate, diluted 1:1000 in diluent (or according to manufacturers recommendation), to each well of the plate.
- 3) Incubate for one hour at 37°C.

*(vii) Substrate*

- 1) Wash plate four times, as above.
- 2) Prepare the substrate dilution during the washing procedure. Add 0.1 ml of the substrate solution to each well.
- 3) Incubate for at least 10 minutes at room temperature in the dark

*(viii) Stop and read absorbance*

- 1) Stop the substrate reaction by adding 0.1 ml of 2N H<sub>2</sub>SO<sub>4</sub> in the same sequence and at the same time interval as when the substrate solution was added. The colour in the wells with a positive reaction will change from blue to yellow.
- 2) Dry bottom of the plate before reading it.
- 3) Measure the optical density (OD) of each well at 450 nm using a spectrophotometer within 30 minutes after stopping. The control wells,

---

incubated with diluent only, serve as blanks. Read the wells with NSL and SL controls and perform the validity checks described in the section below.

#### 8.1.4 *Quality control and interpretation of results*

Given a test with Sabin-positive control, non-infectious non-Sabin positive control and one unknown virus, and observed OD values A to I, the following validity checks and interpretation are made.

	Anti-total	Anti-NSL	Anti-SL
Sabin	A	B	C
Non-Sabin	D	E	F
Virus	G	H	I

#### **Test is valid only if:**

OD values A, D and G are  $\geq 1.000$

OD values C and E are  $\geq 0.700$

OD values B and F are  $\leq 0.300$

Ratio C/B  $\geq 2.5$  and

Ratio E/F  $\geq 2.5$

#### **Interpretation of results:**

Ratio H/I  $\geq 2.5$

Non Sabin-like virus (i.e. "wild")

Ratio I/H  $\geq 2.5$

Sabin-like virus

If both ratios are  $< 2.5$  and H and I are  $\geq 0.400$

Double reactive virus

If both ratios are  $< 2.5$  and H and I are  $< 0.400$

Non-reactive virus

If G  $< 1.000$  but  $> 0.400$

Invalid test: regrow isolate to higher concentration

If G  $< 0.400$

Invalid test: check serotype of isolate

See Section 8.4 for interpretation and action.

---

## Troubleshooting ELISA

Problem	Possible causes and solutions
All reactions negative, including positive control.	Test component missing. Wrong antiserum used for coating (e.g. anti-P1 serum used to coat plate for a P2 test).
Low OD values for all samples and controls, e.g. all reactions with anti-total < 1.00.	Problems with coating step: low concentration of bovine anti-poliovirus serum; incorrect pH of coating buffer. Substrate not appropriately prepared or has lost activity. Conjugate used at wrong concentration (NB. Users may need to determine the correct concentration to be used, particularly if a new batch or lot number of reagent was used in the invalid test). Low binding of plate (sometimes occurs if new plates received or different supplier used for plates); plate allowed to dry out in between washes; or inappropriate microtitre plate used. Pipettor requires calibration (may be delivering low volumes). Incorrect pH of dilution buffer.
All OD values of test too high, including high background in blank wells.	Over-incubation with substrate. Blocking step omitted. Too few wash steps used. Problem with washing buffer. Problem with washer.
Single or multiple wells, with the same location, give persistently high OD values on different test runs.	Blocked manifold or problems with the washer.
OD values for controls are valid, but occasional sample gives invalid results because OD with anti-total antiserum < 1.0 but $\geq 0.4$ .	Virus is at too low concentration. Make a passage of the virus (preferably in RD cells grown on MEM + 2 % FCS) and repeat the test.
OD values for controls are valid, but occasional sample gives invalid results because OD with anti-total antiserum < 0.4.	Serotyping error.
OD values for NSL controls too low.	Incorrect dilution or storage (should be 4°C) of NSL controls.
OD values for SL controls too low or incorrect.	Regrow low passage of in-house SL control stock to high titre.
Low specificity of SL or NSL serum (sera do not fulfil indicated OD criteria).	Check with producer of reagents (RIVM) by sending details on performance of reagents including batch numbers

---

## 8.2 Probe hybridization method for intratypic differentiation

### 8.2.1 Test principle

RNA probe hybridization is done on identified typed polioviruses of high titre. The viral RNA is extracted and immobilised on to filters. Digoxigenin-labelled enterovirus group, Sabin type-specific, and wild virus genotype-specific probes are added and allowed to hybridise to the immobilised RNA (NB. wild virus genotype-specific probes are usually only supplied to laboratories serving polio endemic countries). Unbound probe is removed by washing and bound probe is detected using a colorimetric reagent. CDC supplies a kit containing essential reagents to carry out probe hybridization which is obtainable through WHO.

### 8.2.2 Kit components

The kit contains:

- 1) Digoxigenin (DIG) labelled RNA probes (four vials: Enterovirus Group, Sabin 1, Sabin 2, Sabin 3) that are ~100 nt RNA transcripts with antisense polarity capable of forming stable base pairs with target sequences on Sabin strain genomes.
- 2) The unlabelled non-infectious positive control RNA transcripts are ~1350 nucleotides long, are of sense polarity (equivalent to non-infectious genome fragments), and contain the three Sabin strain sequences (Sabin 1, Sabin 2, Sabin 3) targeted by the probes and by Poliovirus Diagnostic PCR Primers, and three wild poliovirus negative-control RNAs (P1W, P2W, and P3W) containing corresponding sequences of extinct wild polioviruses from the Americas.

The reagents have been lyophilized to preserve activity and to facilitate shipment and storage.

**Resuspend the RNA probes in 20µl of the supplied nuclease-free distilled water and use 5 µl. Store at -20°C after reconstitution.**

RNA, **Sabin and wild**, supplied for control – 500 ng, resuspend in 200 µl of nuclease-free water supplied. Aliquot 10 µl in 20 tubes and store at -20°C. Take one tube out each time and pipette 5 µl of the RNA to a 1.5 ml microcentrifuge tube containing 495 µl of nuclease-free water or 10 mM Tris pH 7.0. pH should not be more than 7.5, otherwise RNA will degrade in slightly alkaline pH. This dilute solution should not be kept at room temperature for a long time. Discard the residual RNA solution.

Each box may be reordered separately, as they may not be exhausted at the same rate.

Other materials required but not supplied are:

- nylon membranes
- blocking reagent (specify)
- anti-DIG Fab alkaline phosphatase conjugate
- chromogenic or chemiluminescent alkaline phosphatase substrate

- 
- thick filter paper
  - manifold
  - vacuum pump

### 8.2.3 Test procedure

#### (i) Sample preparation

- 1) For best results, isolates should be grown in RD monolayer cultures in Minimal Essential Medium (MEM) (lacking fetal calf serum) to produce high-titre stocks. Since poliovirus grows to higher titres in RD cells, as compared to L20B cells, the additional virus in the RD passage will give a stronger signal in the probe hybridization test. Large amounts of fetal calf serum in the virus sample can reduce the binding of the RNA to the membrane resulting in a weaker signal in the test.

**Caution: Steps 2 to 7 should be performed in a biological safety cabinet.**

- 2) After development of 4+ CPE, suspend the infected cells, and liberate virus by two freeze-thaw (dry ice-ethanol bath or freezer/36°C) cycles.
- 3) Prepare “formaldehyde mix” (avoid breathing formaldehyde fumes, use a fume hood if available):

20X SSC	0.3 µl/sample
37% formaldehyde	0.2 µl/sample

(20X SSC is 3.0 M NaCl, 300 mM sodium citrate; pH 7.0.)
- 4) Dispense 0.5 ml formaldehyde mix into each 1.5 ml microcentrifuge tube.
- 5) Transfer 0.6 ml of culture fluid to a separate 1.5 ml tube. Pellet the cellular debris in a microcentrifuge (>10 000 g for 1 minute).
- 6) Transfer 0.5 ml of supernatant to the appropriate 1.5 ml tube containing the formaldehyde mix.
- 7) Vortex thoroughly to mix and incubate at 65°C for 15 min.

**Note:** Incubation at 65°C in 3.7% formaldehyde completely inactivates poliovirus infectivity. Subsequent work can be performed on an open laboratory bench.

Because RNA molecules are degraded upon prolonged exposure to formaldehyde, prepare only enough formaldehyde-treated samples as will be used immediately.

#### (ii) Immobilization of poliovirus RNA onto membrane filters

- 1) Cut the corners from the sheets of the thicker filter paper and the nylon membrane filters so that the alignment pins in the manifold will be clear. Mark the corner of the nylon membrane with a pencil to identify well A1. *Do not touch* the nylon filters with your fingers (wear gloves and use filter forceps), as oils from the skin will interfere with RNA binding to the filter.
- 2) Saturate a piece of thick filter paper with 20X SSC and place it on the manifold.
- 3) Float the nylon membrane in a shallow container of distilled water to wet. After 30 seconds invert the membrane to thoroughly wet it.

- 
- 4) Drain off excess water and briefly soak the membrane in 20X SSC by the method described in step 3.
  - 5) Position the nylon membrane on top of the thicker filter paper. Clamp the “sandwich” together and gently apply vacuum. To ensure that none of the wells is blocked, filter 200 µl of 6X SSC through all wells. Air bubbles prevent complete filtration of the sample and can be removed by gently tapping the manifold on the bench. After the wells are cleared, turn off vacuum.
  - 6) Apply samples (up to 0.2 µl) to the nylon membrane with a micropipette by dispensing down the wall of each well.
  - 7) Spot samples in four identical sets, one set for each probe to be used. Positive and negative control RNA transcripts for each serotype should be included in each test run. At least two sets are needed:
    - one set for the group probe, and
    - one set for each strain-specific probe.
  - 8) After all samples have been dispensed, gently apply vacuum until all wells are empty. Disassemble the manifold and carefully remove the nylon membrane.
  - 9) Irradiate the nylon membrane on a transilluminator for three minutes to cross-link the RNA to the nylon membrane. Caution: avoid exposure to ultraviolet radiation. Wear a face shield, long sleeve lab coat, and plastic gloves. The nylon filter is now ready for hybridization.

*(iii) Hybridization*

- 1) Pre-hybridization step: Cut the nylon membrane into separate sample sets. Place nylon membranes in plastic sandwich boxes containing 1 ml of hybridization buffer [6x SSC, 50% (v/v) formamide, 0.1% (w/v) SDS, 2% (v/v) blocking reagent] for each cm<sup>2</sup> of membrane. Several filters may be placed in the same box. Seal plastic boxes and incubate at 65°C for two hours in a shaking water bath (120 RPM).
- 2) Hybridization step: After pre-hybridization, drain the buffer and add 0.1 ml of hybridization buffer for each cm<sup>2</sup> of nylon membrane (one-tenth the volume used for pre-hybridization. For example, for 24 dots use 5 ml probe in 5 ml buffer).
- 3) Add the probe to the hybridization buffer using a micropipette.
- 4) Seal each box and transfer to a 65°C shaking water bath (120 RPM).
- 5) Incubate overnight.
- 6) Transfer the nylon membranes to shallow containers, such as sealable plastic food containers, for washing. Hybridization solution containing probes can be stored at -20°C for reuse up to three times.

*(iv) Filter washing*

- 1) Wash the nylon membranes once for 15 minutes at 75°C with shaking in 25 ml Wash Buffer 1 (2X SSC, 0.1% (w/v) sodium dodecyl sulfate [SDS]).
- 2) Wash the nylon membranes once for 15 minutes at 75°C with shaking in 25 ml Wash Buffer 2 (0.1X SSC, 0.1% (w/v) SDS).

---

(v) *Binding of anti-DIG Fab alkaline phosphatase conjugates to bound RNA probes*

- 1) Following hybridization and post-hybridization, equilibrate the membrane in 25 ml Buffer A (100 mM maleic acid, 150 mM NaCl; pH 7.5) for 1 min.
- 2) Decant and drain Buffer A. Add 25 ml Buffer B (2% blocking reagent in Buffer A). Do not allow the membrane to dry.
- 3) Incubate filter for at least one hour with gentle shaking.
- 4) Near the end of the blocking step, dilute the anti-DIG Fab alkaline phosphatase conjugate 1:5000 in Buffer B for a working concentration of 150 mU/ml.
- 5) Remove the membrane from Buffer B (step 3) and transfer it to the Fab conjugate solution.
- 6) Incubate for 30 minutes with gentle shaking.
- 7) Drain the conjugate solution and gently wash the membrane twice for 15 minutes each in 20 ml of Buffer A.
- 8) Equilibrate the washed nylon membrane in 10 ml freshly prepared Buffer C (100 mM Tris-HCl, 100 mM NaCl, 50 mM MgCl<sub>2</sub>; pH 9.5) for 2 minutes.

(vi) *Hybrid detection using chromogenic substrates*

- 1) Prepare chromogenic substrate (45 µl of 100 mg/ml NBT and 35 µl of 50 mg/ml BCIP in 10 ml Buffer C). Typically 10 ml is required for each 100 cm<sub>2</sub> of membrane. NBT is 4-nitroblue tetrazolium (stock in 100% dimethyl formamide [DMF]). BCIP is 5-bromo-4-chloro-3-indolyl-phosphate (stock in 70% DMF). Store NBT and DMF in dark in glass or polypropylene tubes.
- 2) Drain Buffer C. Add chromogenic substrate.
- 3) Incubate for 30 minutes in dark. If satisfactory colour development is observed, rinse filter in Buffer C.
- 4) Record results by Polaroid photography.

#### 8.2.4 Interpretation

- Group probe hybridizes to all polioviruses and enteroviruses.
- Sabin-specific probes hybridise to respective Sabin strains.
- Wild polioviruses form hybrids with the group probe and with the corresponding wild genotype-specific probe (if available).

The example blot below (*Figure 8.2*) shows results from four replicate filters each containing six vaccine-derived and six wild poliovirus samples of each serotype. Samples were tested with the four probes indicated above each filter.

See Section 8.4 for interpretation and action.



Figure 8.2: Example probe hybridization blot

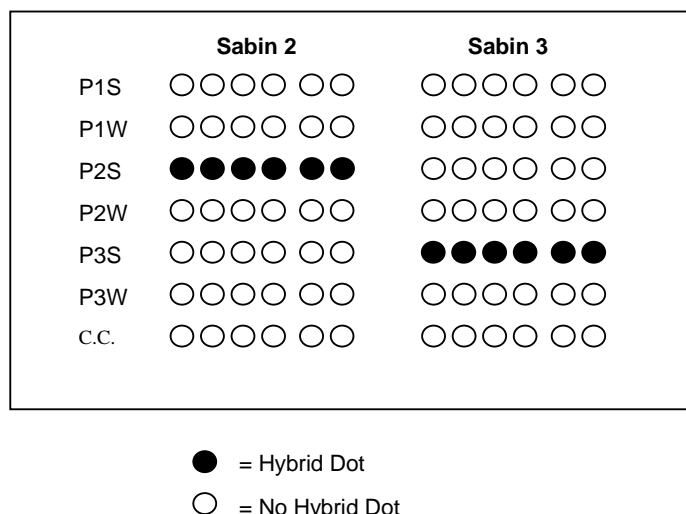

### 8.3 PCR method for intratypic differentiation

#### 8.3.1 Test principle

The poliovirus diagnostic PCR is done on identified typed polioviruses. The viral RNA is released by heat and converted to complementary DNA (cDNA) using reverse transcriptase. The cDNA is amplified in a conventional PCR reaction using Taq polymerase. The PCR products are resolved by gel electrophoresis to determine size and function as confirmation of product authenticity. Both the cDNA synthesis and the PCR reaction use multiple sets of oligonucleotide primers with different specificities. Analogous to probe hybridization, primers include specificity for the enterovirus group and Sabin type-specific for each of the three serotypes. Additional primers are used that amplify all polioviruses and all isolates of each of the three serotypes. This combination of primers will result in characterization of poliovirus isolates and will also confirm the serotype identification of the isolate. CDC supplies a kit containing essential reagents (without enzymes) to carry out poliovirus diagnostic PCR which is obtainable through WHO.

---

**Good laboratory practice:** Because the PCR technique involves amplification, PCR-product carryover (cross-contamination) represents a significant problem. Observing the following good laboratory practices can diminish the risks.

- Use a separate room or containment unit (biological safety cabinet equipped with UV light) for pre- and post-PCR.
- Use separate sets of pipettors and other equipment for pre- and post-PCR procedures.
- Aliquot reagents and store to minimize the number of repeated samplings.
- Prepare and aliquot reagents in an area that is free of PCR-amplified products.
- Prepare oligonucleotides in an environment free of PCR products.
- Always use aerosol-resistant tips.
- Wear gloves (talc free) and change frequently.
- Uncap tubes carefully to prevent aerosols.
- Minimize sample handling
- Add non-sample components to the reaction tubes before adding the nucleic acid sample.
- Cap each tube after the addition of RNA before proceeding to the next sample.
- Use a positive control; select a sample that amplifies consistently.
- Use well-characterized negative controls.
- Include multiple reagent controls with each amplification. It should contain all of the necessary components for PCR except the template RNA.

### 8.3.2 *Kit components*

The kit is supplied in three parts.

#### **Box 1**

- four vials of primers in Buffer A (Serotype 1, Serotype 2, Serotype 3, Sabins);
- positive controls for each primer set (four vials);
- for convenience and to reduce reagent use, the three Sabin-specific primer pairs are combined in a single multiplex reaction. **The degenerate primer pairs should not be multiplexed, as non-specific reaction products will be amplified.**

#### **Box 2**

- two vials of primers in Buffer A (Pan-Enterovirus and Pan-Poliiovirus);
- appropriate controls for each primer set (two vials).

#### **Box 3**

- six vials of Buffer B (to which DTT and enzymes should be added prior to the first use);
- one vial of DTT;
- one vial of 1x PCR buffer for diluting DNA molecular weight marker;
- one copy of package insert.

---

Each box may be reordered separately, as they may not be exhausted at the same rate.

Required but not supplied are the following:

- enzymes (placental RNase inhibitor, AMV reverse transcriptase, and taq DNA polymerase)
- molecular weight markers
- gel loading dye 6x (Bromophenol blue)
- ethidium bromide (1µg/ml)
- nuclease-free water.

Key to cap and insert colours	
Vial	Cap
PanEV + Buffer A	Purple
PanPV + Buffer A	White
Serotype 1 + Buffer A	Yellow
Serotype 2 + Buffer A	Orange
Serotype 3 + Buffer A	Red
Sabins + Buffer A	Natural
Buffer B and other reagents	Blue

Primer sets have red cap inserts and the corresponding controls have matching caps and yellow inserts.

### 8.3.3 Test procedure

#### (i) RT-PCR reactions

- 1) Prepare the following:
  - Fill out PCR worksheet with name, date, primers, samples and sample order, as well as thermocycler and program identifiers.
  - Label PCR tubes for samples and controls (positive, negative and reagent).
  - Positive control: non-infectious control RNA supplied with Polio PCR kit.
  - Cell control: culture supernatant from uninfected cells, preferably the same cell line and passage as the isolates being tested. Make two cell controls per test run.
  - Reagent control: water instead of sample.
- 2) Thaw virus isolates and PCR reagents on ice.
- 3) For each primer set, dispense 19 µl Buffer A + primers into each tube.
- 4) If a thermocycler with a non-heating lid will be used, add 20 µl sterile mineral oil to each reaction tube.
- 5) Dilute virus sample 1:4 in water or MEM (no serum).
- 6) Add 1 µl of diluted sample or control to the appropriate tubes in biosafety cabinet.

- 
- 7) Incubate five minutes at 95°C in thermocycler or heat block, then quick-chill on ice.
  - 8) Once tube contents have cooled, add 5 µl Buffer B + enzymes. (The first time a vial of buffer B is used, add 0.7 ml 1 M DTT, 6.9 µl 40 U/µl placental RNase inhibitor, 3.6 µl 25 U/µl AMV RT, and 13.7 µl 5 U/µl Taq polymerase and mix. The enzyme mix should be stable for six months at -20°C. Once the enzymes have been added, mark “+E” on the cap with an indelible marker.)
  - 9) Place tubes in thermocycler and cycle as follows (note: if using a thermocycler with a rapid ramp speed, e.g., PE Biosystems 9700, program the ramp from 42°C to 60°C for 45 seconds; all other ramps can use the default ramp time):
    - RT reaction, 42°C, 20 minutes.
    - Inactivate RT, 95°C, three minutes.
    - PCR cycles:
      - Degenerate primers** (panPV and Serotype primers): 95°C for 45 seconds, 42°C for 45 seconds, 60°C for 45 seconds for 30 cycles.
      - Non-degenerate primers** panEV and Sabin primers): 95°C for 45 seconds, 55°C for 45 seconds, 70°C for 45 seconds for 30 cycles.

Cool to 4°C if tubes are not removed immediately after completion of reaction. Reactions may be stored at -20°C if gels will not be run immediately.

*(ii) Polyacrylamide gels*

While PCR reactions are cycling, pour polyacrylamide gels.

30% Acrylamide-Bis, 29:1	5.0 ml
10X TBE Buffer, pH 8.4	1.5 ml (recipe for 10X TBE)
Distilled H <sub>2</sub> O	8.5 ml
10% w/v Ammonium Persulfate	75 µl
Temed	30 µl
Total volume	15 ml ( =enough for two mini-gels, each 8.0 cm x 7.3 cm)

To make 10X TBE: add 108 g Tris-base, 55 g boric acid, and 9.3 g EDTA to 800 mls distilled water. Adjust to pH 8.4 with hydrochloric acid. Make up to 1 litre and autoclave.

Ammonium persulfate should be made fresh or stored in small aliquots at -20°C for up to one year. Assemble gel plates in casting frame and pour two gels, with 0.75 mm thickness spacers and 15-well combs. Polymerize at least 45 minutes. They may also be allowed to polymerize overnight (wrap them in plastic wrap with filter paper soaked in 1X TBE).

- 1) Transfer gels from casting frame to gel apparatus.
- 2) Array 6X gel loading dye (2 µl per reaction) in a 96-well flexible microtiter plate or in drops on parafilm. Mix 10 µl of PCR reaction with a drop of gel loading dye immediately before loading. Combine 1 µl DNA molecular weight marker V (Roche Molecular Biochemicals) with 9 µl 1X reaction buffer and 2 µl 6X loading dye.
- 3) Flush wells with 0.5X TBE. Load each reaction/dye mix on gel using round or flat 0.4 mm gel loading tips. Load positive control in lane 7 and marker in lanes 2 and 14. Load sample and negative controls in remaining lanes, using negative controls to separate sample lanes. (See Figure 7.3).

Make 400 ml 0.5X TBE running buffer by combining 20 ml 10X TBE with 380 ml distilled water.

- 4) Pour running buffer into the gel apparatus, close the lid, and connect to power supply. Run at 20 mA per gel (constant current), approximately 35 to 40 minutes, until bromophenol blue is near bottom.
- 5) Disassemble gels and, if multiple gels were run, mark each by cutting off a different number of well edges, keeping track of the correct gel orientation.
- 6) Stain gels in 1 µg/ml ethidium bromide for 15 minutes with gentle rocking (**CAUTION: ethidium bromide is toxic, mutagenic, and carcinogenic**). **Wear double gloves and handle with care.** Ethidium bromide solution may be reused if stored in the dark in an airtight container.
- 7) Destain gels by rinsing briefly in distilled water.
- 8) Visualize and photograph PCR products using UV transilluminator and Polaroid camera/film (or equivalent).

**Figure 8.3: Gel loading template**

1	2	3	4	5	6	7	8	9	10	11	12	13	14	15
<b>Sample 1</b>	MW Marker	<b>Sample 2</b>	Cell control	<b>Sample 3</b>	Cell control	<b>Positive control</b>	Cell control	<b>Sample 4</b>	Cell control	<b>Sample 5</b>	Reagent control	<b>Sample 6</b>	MW Marker	<b>Sample 7</b>

#### 8.3.4 Interpretation

The results are interpreted by comparing the presence and size of PCR products from test samples to those of positive control reactions. The sizes of each product are shown in Table 8.1. An example gel showing the mobility of positive control amplification products is shown in Figure 8.4. Primers: M, MW marker; EV, panEV; PV, panPV; P1, Sero 1; P2, Sero 2; P3, Sero 3; Sab, Sabins.

**Figure 8.4: Electrophoretic mobility of positive control amplification products**

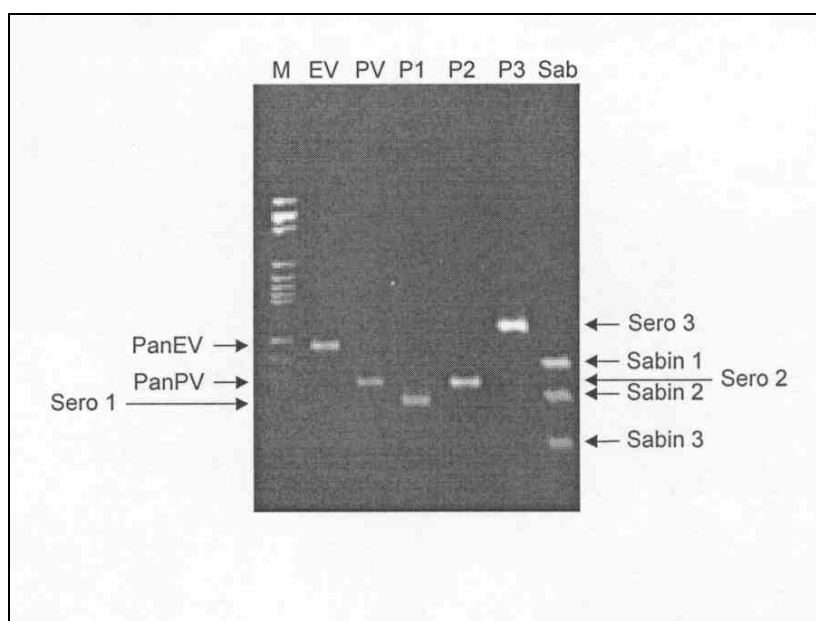

**Table 8.1: PCR interpretation table**

Sample PCR result	Identification
All primers (-)	Non-enterovirus (NEV)
PanEV (+), all others (-)	Non-polio enterovirus (NPEV)
PanEV (+), PanPV (+), Sabins all (-), 1 or more serotypes (+)	Wild poliovirus of indicated serotypes
PanEV (+), PanPV (+), 1 or more Sabins (+), corresponding serotype(s) (+)	Vaccine poliovirus(es) of indicated serotype(s)
PanEV (+), PanPV(+), 1 or more Sabins (+), more serotypes (+) than Sabins	Mixture of wild poliovirus and vaccine virus of different serotypes

Any result not shown in Table 8.1 indicates an error in the test and it must be repeated.

**Table 8.2: PCR primers table**

Primer specificity	Primer sequences	Amplicon size
Pan-Enterovirus (PanEV)	5'-ACACGGACACCCAAAGTAGTCGGTTCC-3' 5'-TCCGGCCCCTGAATGCGGCTAATCC-3'	114 base pairs
Pan-Poliovirus* PanPV)	5'-TTIAIIGCRTGICRTRTT-3' 5'-CITAITCIMGITYGAYATG-3'	79 base pairs
PV-Serotype 1* (Sero1)	5'-ATCATICTYTCIARCATYTG-3' 5'-TGCGIGAYACIACICAYAT-3'	70 base pairs
PV-Serotype 2* (Sero2)	5'-AYICCYTCIACIRCICCYTC-3' 5'-TGCGIGAYACIACICAYAT-3'	79 base pairs
PV-Serotype 3* (Sero3)	5'-CCIAIYTGITCRRITTYRTC-3' 5'-AAYCCITCIRTITTYTAYAC-3'	140 base pairs
Sabin 1 (Sabins)	5'-TCCACTGGCTTCAGTGTT-3' 5'-AGGTCAGATGCTTGAAAGC-3'	97 base pairs
Sabin 2 (Sabins)	5'-CGGCTTTGTGTCAGGC-3' 5'-CCGTTGAAGGGATTACTAAA-3'	71 base pairs
Sabin 3 (Sabins)	5'-AGTATCAGGTAAGCTATCC-3' 5'-AGGGCGCCCTAACTTTG-3'	53 base pairs

Degenerate primers: M = A and C; R = A and G; Y = C and T; I = Inosine.

**Use degenerate PCR conditions with these primer sets.**

### Troubleshooting PCR

Problem	Possible causes
All reactions negative, including positive control	Component missing, wrong thermocycler profile used, or bad reagent(s).
No amplicon with positive control; some sample reactions positive	Control RNA degraded or not added.
Amplicon with cell control, reagent control negative	Cell control contaminated with virus or amplified DNA. Obtain new cell control.
Amplicon with reagent control, cell control negative	Water used as reagent control contaminated with amplified DNA
Amplicon with reagent control and cell control	Reagents contaminated with amplified DNA.
Positive reaction with one or more Sabin pairs, but corresponding Serotype pairs and/or PanPV are negative	Ensure that serotype PCR was performed with 42°C annealing temperature. Ensure that ramp time for 42°C to 60°C step is approximately 45 seconds.
Positive reaction with PanPV primers, but all serotype pairs are negative	Very infrequently (< 0.1% of isolates), the panPV primers may amplify a band of 82 base pairs from certain coxsackievirus A24 isolates. The isolate should be referred to a Specialized Reference Laboratory for identification.

## 8.4 Protocol for use of two methods of intratypic differentiation of polioviruses

The methods of intratypic differentiation that have been selected for routine use and support in the Network are based on different approaches. ELISA with polyclonal cross-adsorbed antisera detects antigenic differences between wild and Sabin-derived strains, whereas nucleic acid probe hybridization and diagnostic PCR are molecular methods, detecting differences in the viral RNA.

It has been observed that the majority of VDPVs (i.e. isolates with 1 to 15 % VP1 sequence divergence to Sabin strains) give contradictory results in ITD tests based on different approaches. Some of these VDPVs exhibited neurovirulence and enhanced capacity for person to person transmission. Contradictory ITD results can therefore be used to “flag” isolates of possible programmatic importance. All laboratories doing ITD tests must use two ITD methods based on different approaches for testing of all poliovirus isolates. Alternatively, complete VP1 sequences must be available on all poliovirus isolates tested by only one ITD method, provided that both ITD and VP1 sequence results are available for programme use within 14 days of detection of poliovirus isolates.

The reporting protocol for use of 2 ITD methods is described in Table 8.5.

**Table 8.3: Protocol for use of ELISA test and nucleic acid probe hybridization/PCR in intratypic differentiation**

Result	ELISA Result	PROBE/PCR Result	ACTION
1.	Wild	Wild	Report wild. REFER to GSL
2.	Sabin	Sabin	Report Sabin
3.	Double reactive	Wild <sup>†</sup>	Report probable? wild. Refer
4.	Double reactive	Sabin	NOTIFY* AND REFER to GSL
5.	Double reactive	Weak reaction	NOTIFY* AND REFER to GSL
6.	Non-reactive	Wild	NOTIFY* AND REFER to GSL
7.	Non-reactive	Sabin	NOTIFY* AND REFER to GSL
8.	Non-reactive	Weak reaction	NOTIFY* AND REFER to GSL
9.	Wild	Weak reaction	Report probable? wild. Refer
10.	Sabin	Weak reaction	NOTIFY* AND REFER to GSL
11.	Sabin	Wild	NOTIFY* AND REFER to GSL
12.	Wild	Sabin	NOTIFY* AND REFER to GSL

\* The National Laboratory (if referred sample) or national programme (if from RRL's country) and regional laboratory coordinator should be notified of all equivocal results.



---

**Notes:**

**Results 1 and 2:** If there is agreement between the tests, then a report can be made with confidence. All wild viruses should be referred for sequencing.

**Result 3:** A mixture of wild and Sabin of the same serotype, an intermediate strain, or vaccine-derived poliovirus, will give a double-reactive result in the ELISA test. If the Probe/PCR test indicates “wild” then Sabin is absent and wild virus may be reported.

**Result 4 and 5:** If the ELISA result is double-reactive and the Probe/PCR test indicates “Sabin”, it is possible that a wild virus may be present in a mixture, or that a vaccine-derived poliovirus is present, and the strain should be referred for further characterization. No definitive report should be made. See below for suggested wording

**Result 6:** A non-reactive result in the ELISA may be a wild poliovirus not recognized by the cross-adsorbed antisera. If the Probe/PCR test indicates “wild” then the result is inconclusive and this strain should be referred.

**Result 7 and 8:** A non-reactive result in the ELISA may be a wild poliovirus not recognized by the cross-adsorbed antisera. If the Probe/PCR test indicates “Sabin” or has a “weak reaction” then this may be a discrepant result and the strain should be referred.

**Result 9:** A weak reaction in the Probe/PCR test may indicate a low concentration of viral RNA. If the ELISA test gives a “wild” reaction, this is reported and the strain should be referred for further characterization.

**Result 10:** If the probe test gives a weak reaction and the ELISA test indicates “Sabin”, the result should not be reported. The strain should be referred.

**Result 11 and 12:** No report should be made if the ELISA and Probe/PCR tests give completely contradictory results. A vaccine-derived poliovirus may be present and the strain should be referred for further characterization.

Suggested wording of reports for results 4 to 12: *“Poliovirus type x was isolated. Results of intratypic differentiation are not conclusive and the virus has been referred to a Global Specialized laboratory for further characterization.”*

Poliovirus isolates tested by both probe hybridization and PCR methods must give the same result. Otherwise the strain should be referred for further characterization.

The National Laboratory (if referred sample) or national programme (if from RRLs country) and regional laboratory coordinator should be notified (within one working day) of all poliovirus strains that give contradictory or inconclusive ITD results. Laboratories should refer aliquots of such strains to the GSL as soon as possible and not waste time trying to resolve the problem on their own.

---

## 9. Investigating wild poliovirus contamination of cell cultures

The virology laboratory has a critical role to play in poliomyelitis eradication. Laboratory results are used to monitor the temporal and geographic occurrence of wild polioviruses, investigate the relationships among viruses, classify poliomyelitis cases and target immunization activities. Reporting the isolation of a wild poliovirus from an acute flaccid paralysis (AFP) case triggers a number of responses, including field surveillance to detect any additional poliomyelitis cases, and, increasingly in the final stages of the eradication programme, the implementation of costly “mopping-up” immunization responses in an effort to break the last remaining transmission chains. Accurate and timely laboratory results are therefore of paramount importance. The reporting of a wild poliovirus where none exists can have serious consequences in the form of wasted financial resources, unnecessary diversion of time and effort of field personnel, damage to the reputation of the laboratory and undermining of the confidence of the laboratory’s staff and its users.

Investigations should begin immediately whenever there is suspicion of wild poliovirus contamination. Since the incident may have important implications for the planning of field responses, the regional laboratory coordinator should be informed immediately. He/she will assist, or arrange for other expert virologists to assist, in investigating the incident within the originating laboratory. The coordinator will also expedite the investigation among reference laboratories performing intratypic differentiation (ITD) or genomic sequencing.

### 9.1 When to suspect wild poliovirus contamination

Laboratories should suspect contamination and implement follow-up investigations in any of the following situations:

- unusual clustering of wild poliovirus positive results in place (e.g. all reported from a single laboratory) or time (e.g. all reported within the same week);
- incompatibility between the laboratory and epidemiology findings;
- reporting of identical nucleic acid sequences for wild polioviruses from different patients with no obvious epidemiological link, especially if patient samples were tested in the same laboratory.

---

A thorough review should be made of all laboratory procedures and practices to determine the possible origin of contaminants. The following guidelines can assist laboratories in the follow-up investigations and in implementing measures to minimize the risk of contamination. The guidelines are focused on wild polioviruses because of their programmatic impact. However, laboratories should also investigate suspected Sabin virus or non-polio enterovirus contamination since the underlying causes and corrective actions are similar for these categories of viruses.

## 9.2 Investigating potential sources of wild poliovirus contaminants

Wild polioviruses can be derived from reference materials, inoculated specimens, mis-identified or contaminated virus stocks. Contamination can occur if wild viruses from these sources become introduced into other specimens being tested at the same time. Questions to be answered include:

- *What polio virus reference strains are present in the laboratory?*

Only OPV-derived strains should be used for reference in National laboratories. All viable wild poliovirus reference strains should be destroyed or locked away with controlled access. Non-infectious controls, available through the WHO global polio laboratory network, should be used in assays for ITD of polioviruses by ELISA, probe hybridization and PCR. Laboratories performing other ITD procedures that are not currently supported by WHO should use control strains with readily identifiable molecular markers to facilitate easy differentiation from wild viruses of recent origin.

- *What contemporary or past poliovirus and non-polio enterovirus isolates are present in the laboratory?*

Non-serotyped enteroviruses, mis-typed enteroviruses, polioviruses that have not been differentiated as wild or vaccine like, or polioviruses evaluated by non-WHO recommended ITD methods may be inadvertent sources of wild polioviruses, depending on the time and place of their origin. Past enterovirus and poliovirus isolates that are no longer required should be destroyed after verifying with the WHO regional laboratory coordinator that the poliovirus isolates have no programmatic value. Past poliovirus and non-polio enterovirus isolates should be handled at a separate time from contemporary patient samples or isolates, and manipulated at biosafety level 2 by experienced personnel who have received polio vaccination.

- *What wild poliovirus potentially infectious patient or environmental samples are present in the laboratory?*

Wild polioviruses can be present if such samples have been collected at a time or place of wild poliovirus transmission. Such samples represent a risk if mislabelling errors occur during testing and/or if there is physical cross-contamination through inadvertent transfer of materials into cell cultures inoculated with contemporary samples handled at the same time.

- 
- *What virus reference stocks are present in the laboratory that have been grown on polio permissive cell lines?*

Some rhinovirus and non-polio enterovirus reference strains have been reported to harbour polioviruses. Some of these strains may have been prepared in animals or cell lines of primate origin in which poliovirus can also replicate. Laboratories should confirm the serotype and identity of virus stocks and reference strains (e.g. by neutralization tests or plaque reduction assay), and exclude the presence of polioviruses.

### 9.3 Determine if there are lapses in good laboratory practices

Gradual deviations in routine laboratory practices, shortcuts or new practices can introduce opportunities for contamination, often with the operator being unaware of potential problems. Investigations should include careful review of laboratory practices of all personnel. Investigations should include the following questions:

- *Are specimen and virus storage containers leak-proof with externally threaded screw caps?*

Failure to use containers of this design can lead to adverse events when containers are opened e.g. creation of aerosols or splashes, contamination of the outside of containers and contamination of the hands of workers.

- *Are specimens and inoculated cell cultures only opened and manipulated in a class II biosafety cabinet designated for infectious work?*

Observations should also include cabinet airflow and work practices within the cabinet, particularly the presence of materials and equipment that may impede airflow. Also important are verification and certification of maintenance checks of BSCs, and use of appropriate disinfectants for their decontamination.

- *Are media mixed or poured from inoculated cultures or are there other avoidable opportunities for creating aerosols?*

The creation of aerosols or splashes can result in contamination of the worker, equipment, the environment or the work. Numerous opportunities exist in virology laboratories for creation of aerosols or splashes, e.g. vortexing, centrifuging, mixing of samples or cultures, decanting cell culture fluids, pipetting materials, opening specimen containers or cell cultures. Work procedures can be adjusted to minimize the risks posed by these activities. For example, samples and cell culture fluids should be placed in screw-capped covered tubes when vortexing or centrifuging.

- *Are pipettes handled properly when inoculating or passaging cell cultures?*

Pipetting techniques provide notorious opportunities for inadvertent virus transfer between cell cultures handled at the same time. Simple precautions can be taken such as ensuring that only a single culture is ever open and manipulated at any given time, using disposable pipettes, and limiting pipette use to a single culture before discarding. Only sterile, individually wrapped, cotton-plugged pipettes should be used in areas where inoculated cell cultures or virus isolates are handled. If, in exceptional situations, pipettors are substituted for volumetric

---

pipettes, then the pipettor tips should be aerosol-resistant and plugged. The body of the pipettor should never be introduced into inoculated cell cultures.

- *Are specimen containers, work surfaces and laboratory wastes properly decontaminated?*

Paper towels, cotton swabs or other materials used for wiping containers or surfaces should be treated as infectious wastes. Any disinfectants used to wipe sample containers or work surfaces should be active against polioviruses, and should be used at the correct concentration with the appropriate exposure time. Laboratory wastes should be placed directly into autoclavable containers and autoclaved before discarding.

- *Are remnants of stool samples stored in original containers at -20° C for at least 12 months?*

This is important in case of a need to repeat the virus isolation process.

- *Could materials have been mis-labelled during testing?*

Transfer of materials to unlabeled containers is the most common cause of switched specimens. A wild poliovirus result may be assigned to the wrong patient or sample if mis-labelling occurs while a wild poliovirus sample is being manipulated. To avoid this risk, samples and cell culture materials should always be transferred into pre-labelled tubes. A good practice is to assign a unique identifying laboratory number to each sample as it is “logged in” on receipt. This is usually the only time when the laboratory number is physically linked to a patient’s name. Workers should visually cross check when cultures are being manipulated to ensure a match between the number written on the culture and that written on the pre-labelled tube to which material is being transferred. Equally important is cross checking the accuracy of sample numbers on written documentation of work being performed.

#### **9.4 Determine if samples can be tracked**

Meticulous laboratory records should be maintained and should be available for review. Accreditation requires laboratories to retain written records of all procedures and the dates performed. Often, though not always, it is possible to identify an opportunity for contamination by reviewing laboratory records. It should be possible to answer the following questions during the investigation of a suspected contamination event.

- 
- *Which other samples were handled at the same time or on the same dates as the suspected contaminant?*

This review should extend to all stages of testing i.e. inoculation, passage, serotyping, and ITD.

- *Have all samples been re-tested that were handled at the same time as the suspected contaminant?*

Re-testing of original stool samples of suspected contaminants is advised. Laboratories should refer original stool samples in their original containers to global specialized laboratories for further investigations and to expedite the provision of re-testing results and sequence data. Laboratories may perform repeat tests on the stored stool suspensions available in their own facility while awaiting results from the global specialized laboratory. Non-reproducibility of the original wild poliovirus positive result often provides strong evidence of contamination.

## **9.5 Communicate with the Programme during the investigation**

Every laboratory within the global polio laboratory network is required to report all wild polio-virus positive results. Every report is usually assumed to be correct unless proven otherwise. Reports of wild polio-virus isolation, particularly in historically or recently polio-free countries, triggers a rapid field response. Field surveillance activities should include investigation of the case (clinical data, immunization status, history of travel, or contact with persons from endemic countries) and search for additional AFP cases in the area of the reported case. Full and timely communication between the programme and the laboratory is crucial during the resolution of incidents of suspected contamination.

---

# 10. Specimen and isolate transport

Proper transport under optimal conditions of specimens, isolates, and cell lines is vital to the effectiveness of the global polio laboratory network. Successful shipment of these materials must comply with a number of international and national regulations. Failure to meet these regulations can result in unnecessary delays, loss of viability of specimens, or an increase in the risk of accidentally exposing transport personnel, the sender, receiver, or the public, to potentially infectious materials. Hand carriage of infectious substances is strictly prohibited by international carriers, as is the use of diplomatic pouches for that purpose.

Successful shipment of materials within the global polio network laboratory requires advanced planning, appropriate packaging, labelling, documentation and communication between all parties involved — the sender, carrier, and receiver.

## 10.1 Transport planning

It is the responsibility of the sender to ensure the correct designation, packaging, labelling and documentation of all materials sent from the laboratory.

The efficient transport of infectious materials requires good coordination between the sender, the carrier, and the receiver (receiving laboratory), to ensure that the material is transported safely and arrives on time and in good condition. Such coordination depends upon well-established communication and a partner relationship among the three parties.

### *10.1.1 Make advance arrangements with the receiver*

Once it has been decided that materials need to be shipped from the laboratory, the receiver should be contacted and informed of the nature of the materials to be sent. The sender should enquire about any import permits required by the receiving laboratory's national government. If permits are needed, the receiving laboratory will need to obtain the CURRENT permit and send it (usually a faxed copy) to the shipping laboratory so that the permit can be given to the carrier. The sender should seek information from the receiver concerning recommended carriers. The sender and receiver should then make advance arrangements for a mutually convenient time for shipment to ensure that the appropriate staff are available to receive the shipment. It is recommended that weekend arrivals be avoided.

---

### 10.1.2 *Make advance arrangements with the carrier*

Now that the receiving laboratory knows that a shipment is necessary, the sending laboratory should contact a carrier familiar with handling infectious substances and diagnostic specimens and make arrangements to ensure that:

- the shipment will be accepted;
- the shipment is sent by the most direct routing, avoiding weekend arrival;
- archives and documentation of the shipment progress will be kept;
- the conditions of the shipment while in transit will be monitored;
- the sender will be notified of any delays.

The sender should ask about any necessary shipping documents that the carrier may require or any specific instructions necessary to ensure safe arrival of the shipment. The carrier may also provide advice on packaging.

## 10.2 Packaging the materials for transport

Properly packaging and labelling of the material being shipped is vital to maintaining the integrity of the specimens, preventing accidents, and ensuring that there are no delays due to violations of regulations. The packaging requirements for various types of laboratory materials are subject to international and national regulations. There are a number of licensed agencies world-wide that provide training for personnel on how to package materials in compliance with international regulations. It is recommended that all Global Polio Network laboratories have access to personnel who have been licensed as “approved packers” by such an agency.

The international regulations for the transport of infectious materials by any mode of transport are based upon the Recommendations of the United Nations Committee of Experts on the Transport of Dangerous Goods (UN). International organizations such as the Universal Postal Union (UPU), the International Civil Aviation Organization (ICAO), and the International Air Transport Association (IATA) have incorporated these recommendations into their respective regulations. The World Health Organization serves in an advisory capacity to these bodies.

The current regulations specify five types of materials that must meet the requirements for safe transport. The requirements differ depending on which category of material is being shipped:

- **Infectious substances:** those substances known or reasonably expected to contain pathogens. Pathogens are defined as microorganisms (including bacteria, viruses, rickettsiae, parasites, fungi) or recombinant microorganisms (hybrid or mutant) that are known or reasonably expected to cause infectious disease in animals or humans.
- **Biological products:** those products derived from living organisms that are manufactured and distributed in accordance with the requirements of national governmental authorities which may have special licensing requirements, and



---

are used either for prevention, treatment, or diagnosis of disease in humans or animals, or for related development, experimental or investigational purposes. They include, but are not limited to, finished or unfinished products such as vaccines and diagnostic products.

- **Diagnostic specimens:** any human or animal material including, but not limited to, excreta, secreta, blood and its components, tissue and tissue fluids being transported for diagnostic and investigation purposes, but excluding live infected animals.
- **Genetically modified microorganisms and organisms:** microorganisms and organisms in which genetic material has been purposely altered through genetic *engineering in a way that does not occur naturally*.
- **Clinical waste and medical waste:** wastes derived from the medical treatment of humans or animals or from bio-research, where there is a relatively low probability that infectious substances are present.

In general, all of the above categories of materials should be shipped using the basic *triple packaging system*, in addition to the specific requirements necessary for that category (see sections below for category-specific instructions). The packaging materials for this system should be manufactured in compliance with the Dangerous Good Regulations. This ensures that strict performance tests, including a drop and puncture test for PI 602 (infectious substances), have been met. There are a number of manufacturers who can provide containers manufactured to these specifications. Global Polio Network laboratories should keep a reserve of approved packaging for urgent shipments of infectious substances and diagnostic specimens. The triple packaging system is (*see Figure 10.1*):

- 1) **Primary receptacle:** a labelled primary watertight, leak-proof receptacle containing the specimen. The receptacle is wrapped in enough absorbent material to absorb all fluid in case of breakage.
- 2) **Secondary receptacle:** a second durable, watertight, leak-proof receptacle to enclose and protect the primary receptacle(s). Several wrapped primary receptacles may be placed in one secondary receptacle. Sufficient additional absorbent material must be used to cushion multiple primary receptacles. Specimen data forms, letters, and information to identify the specimen, the sender, and the receiver should be placed in a waterproof bag and taped to the outside of the secondary receptacle.
- 3) **Outer shipping package:** the package around the secondary receptacle which protects the receptacle and its contents from outside influences such as physical damage and water while in transit.

Figure 10.1: Triple packaging system



---

The sender should decide which of the categories best describes the material to be sent and then reference the following sections for specific instructions regarding that category of material.

Currently, IATA regulations classify materials for shipping based on establishing a “risk group” for the material. A risk group is characterized by the pathogenicity of the organism, the mode and relative ease of transmission, the degree of risk to both an individual and a community, and the reversibility of the disease through the availability of known and effective preventative agents and treatment. The criteria for each risk group according to the level of risk are as follows:

- a) Risk group 4 (high individual and community risk) — a pathogen that usually causes serious human or animal disease and that can be readily transmitted from one individual to another, directly or indirectly, and for which effective treatment and preventative measures are not usually available
- b) Risk group 3 (high individual risk and low community risk) — a pathogen that usually causes serious human or animal disease but does not ordinarily spread from one infected individual to another and for which effective treatment and preventative measures are available.
- c) Risk group 2 (moderate individual risk and low community risk) — a pathogen that can cause human or animal disease but is unlikely to be a serious hazard, and, while capable of causing serious infection on exposure, for which there are effective treatment and preventative measures available and the risk of spread of infection is limited
- d) Risk group 1 — microorganisms that are unlikely to cause human or animal disease. Substances containing only such microorganisms are not considered infectious substances according to the regulations.

### ***10.2.1 Infectious substances***

Global Polio Network laboratories frequently ship viral isolates. These materials are categorized as infectious substances affecting humans (code UN2814).

Viral isolates for transport must be packaged in sterilized outside thread screw-cap tubes, such as 1.8 ml cryovials (*see Figure 10.2*). The tube caps should be sealed with Parafilm or waterproof plastic tape. Each sealed tube should be placed inside a suitably sized plastic bag together with a small amount of absorbent materials, for example cotton wool. The bag must be sealed, either using a heated bag sealer or waterproof adhesive tape and placed in the secondary container, which also contains absorbent material, such as cotton wool, to absorb any leakage. Tubes of isolates from the same source, and believed to be the same, may be packaged in the same secondary container. Tubes containing isolates from different sources, or believed to be different, should be packed in separate secondary containers.

**Figure 10.2: Packing viral isolates in cryovials**

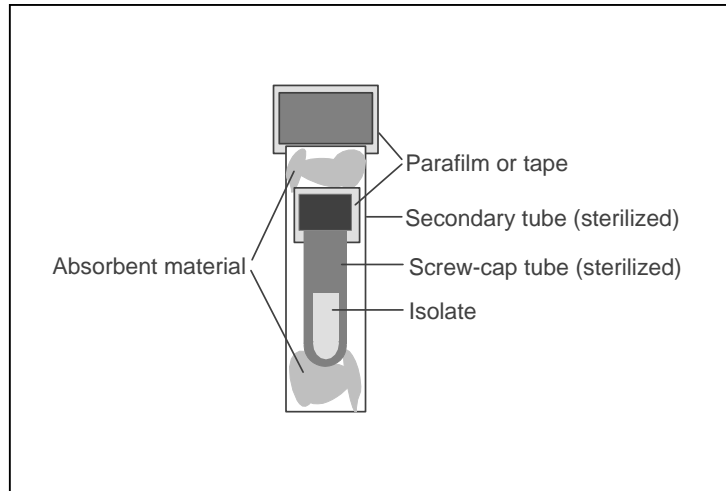

The completed “tube-set” should be placed within insulated containers (polystyrene) with a fibreboard outer packaging. The insulated container and outer packaging must conform to *IATA Dangerous Goods Regulations Packaging Instruction 602* and must be part of a matching set. This ensures that strict performance tests on the package, which include a nine metre drop test and a puncture test, have been met. There are a number of manufacturers who can provide containers manufactured to these specifications. Packaging from approved manufacturers should have the following label printed on the box (see *Figure 10.3*):

**Figure 10.3: Packaging specification marking**



The packaging marking consists of:

- the United Nations packaging symbol;
- type of packing;
- the text “Class 6.2”;
- the last two digits of the year of manufacture of the packaging;
- state authority;
- manufacturer's code.

Packaging without this label does not comply with IATA regulations and risks being rejected by the carrier. Additionally, do not mix components from different manufacturers. Specimen carriers and ice-packs can be reused after thorough washing in water and/or hypochlorite solution.

---

The “tube-set” should be placed within the polystyrene support cage of the insulated packaging. For best results the insulated packaging should be pre-conditioned by storing in a freezer, or filling with dry ice, for at least six hours before the tube-set is put in place.

The maximum volume of infectious substances that can be legally packed in a single package is **50 ml or 50g**, if transport is by passenger aircraft. Otherwise, the limit per package is 4 litres or 4 Kg for transport by cargo aircraft or other carriers. Since each virus isolate is usually approximately 1 ml, the 50 ml limit does not represent a problem.

The spaces around the secondary containers should be filled with dry ice, and the lid of the insulated container placed on top. To allow venting of the dry ice, *the top must not be sealed in any way to permit release of carbon dioxide gas*. Use of dry ice requires a *Declaration of Dangerous Goods Class 9, UN1845 (see Figure 10.4)*, and must comply with packing instruction 904. The instructions given here comply with those rules.

A list of all viral isolates contained in the package should be included in an envelope taped to the top of the insulated lid and placed under the external fibreboard packaging.

The outer packaging must be labelled with the following information (*see Figure 10.4*):

- the sender’s name, address and contact telephone/fax numbers;
- the UN Classification numbers and proper shipping names:  
    “UN 2814 INFECTIOUS SUBSTANCES AFFECTING HUMANS  
    [ENTEROVIRUS]”  
    “UN 1845 DRY ICE”
- the weight of dry ice included in the package when shipment started;
- the receiver’s name, address and contact telephone/fax numbers;
- infectious substances label showing class 6;
- miscellaneous label showing class 9 (indicating dry ice has been used).

**Figure 10.4: Outer packaging and labels for shipment of infectious substances**

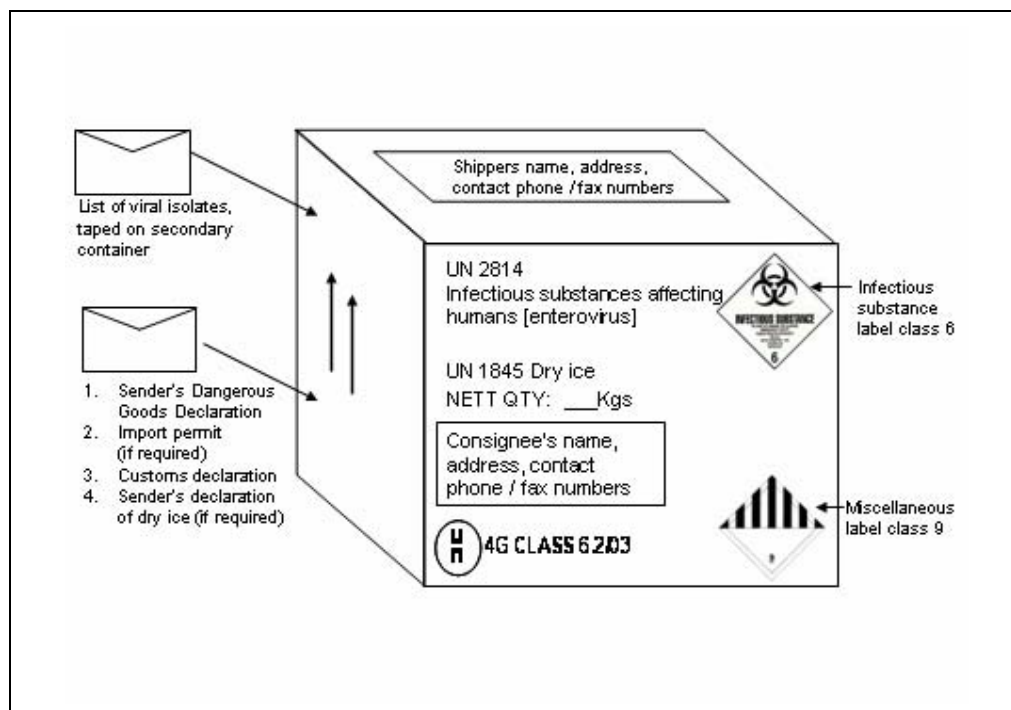

It may be of benefit to include an additional label with the following request: "Refrigerate package where possible". The box should be sealed using wide sealing tape, taking care not to obscure the labels with the tape and leaving a gap for venting of the dry ice.

All infectious substances must be accompanied by a *Sender's Declaration for Dangerous Goods*, indicating shipment of infectious substances and the use of dry ice in the shipment, where appropriate (see *Figures 10.5A and 10.5B*).

Figure 10.5A: Shipper's declaration for dangerous goods

Shipper's Declaration for Dangerous Goods									
<b>Shipper</b> World Health Organization Avenue Appia 1211 GENEVA 27 Switzerland Tel: +41 22 791 2194 Fax: +41 22 791 4837				Air Waybill No. 074 - 1234 - 1234 Page 1 of 1 Page Shipper's Reference Number <i>(optional)</i>					
<b>Consignee</b> Karolinska Hospital Clinical Microbiology Stockholm 17176, Sweden Attn: Dr Göran Kronvall Tel: +46 8 5177 4910 Fax: +46 8 3089 0999									
<b>Transport details</b> This shipment is within the limitations prescribed for: <i>(delete non-applicable)</i> <table border="1"> <tr> <td>Passenger and Cargo Aircraft</td> <td> <input checked="" type="checkbox"/> Cargo  <input checked="" type="checkbox"/> Aerosol  <input checked="" type="checkbox"/> Gas  <input checked="" type="checkbox"/> Liquid                 </td> </tr> </table>				Passenger and Cargo Aircraft	<input checked="" type="checkbox"/> Cargo <input checked="" type="checkbox"/> Aerosol <input checked="" type="checkbox"/> Gas <input checked="" type="checkbox"/> Liquid	Airport of Departure: <b>GENEVA</b>		<b>Warning</b> Failure to comply in all respects with the applicable Dangerous Goods Regulations may be in breach of the applicable law, subject to legal penalties. This Declaration must not, in any circumstances, be completed and/or signed by a consolidator, a forwarder or an IATA cargo agent.	
Passenger and Cargo Aircraft	<input checked="" type="checkbox"/> Cargo <input checked="" type="checkbox"/> Aerosol <input checked="" type="checkbox"/> Gas <input checked="" type="checkbox"/> Liquid								
Airport of Destination: <b>STOCKHOLM</b>				Shipment type: <i>(delete non-applicable)</i> <input checked="" type="checkbox"/> Non-Radioactive <input checked="" type="checkbox"/> Radioactive					
Nature and Quantity of Dangerous Goods <i>(see sub-Section 6.1 of IATA Dangerous Goods Regulations)</i>									
Dangerous Goods Identification									
Proper Shipping Name	Class or Division	UN or ID No.	Packing Group	Subsidiary Risk	Quantity and type of packing	Packing Inst.	Authorization		
Infectious substance affecting humans (poliovirus)	6.2	UN 2814			1 x fibreboard box x 2g	602			
EXAMPLE									
Additional Handling Information <b>INSERT EMERGENCY CONTACT NAME AND TELEPHONE NUMBER</b> Prior arrangements as required by the IATA Dangerous Goods Regulations 1.3.3.1 have been made.									
I hereby declare that the contents of this consignment are fully and accurately described above by the proper shipping name, and are classified, packaged, marked and labelled/placarded, and are in all respects in proper condition for transport according to applicable international and national governmental regulations. Two completed and signed copies of this Declaration must be handed to the operator					Name/Title of Signatory Place and Date Signature <i>(see warning above)</i>				
Distribution: One copy to accompany AWB One copy to be filed at airport of departure (with AWB-copy)									

Form 22902 YP.3.98

Figure 10.5B: Shipper's declaration for standard shipment of infectious substances, with dry ice

Shipper's Declaration for Dangerous Goods											
<b>Shipper</b> World Health Organization Avenue Appia 1211 GENEVA 27 Switzerland  Tel: +41 22 791 2194 Fax: +41 22 791 4837				Air Waybill No. 074 - 1234 - 1234  Page 1 of 1 Page  Shipper's Reference Number <i>(optional)</i>							
<b>Consignee</b> Karolinska Hospital Clinical Microbiology Stockholm 17176, Sweden Attn: Dr Göran Kronvall  Tel: +46 8 5177 4910 Fax: +46 8 3089 0999											
<b>Transport details</b> This shipment is within the limitations prescribed for: <i>(delete non-applicable)</i> <table border="1"> <tr> <td>Passenger and Cargo Aircraft</td> <td><input checked="" type="checkbox"/></td> </tr> <tr> <td>Cargo Aircraft</td> <td><input checked="" type="checkbox"/></td> </tr> </table>				Passenger and Cargo Aircraft	<input checked="" type="checkbox"/>	Cargo Aircraft	<input checked="" type="checkbox"/>	Airport of Departure:  <b>GENEVA</b>		<b>Warning</b> Failure to comply in all respects with the applicable Dangerous Goods Regulations may be in breach of the applicable law, subject to legal penalties. This Declaration must not, in any circumstances, be completed and/or signed by a consolidator, a forwarder or an IATA cargo agent.	
Passenger and Cargo Aircraft	<input checked="" type="checkbox"/>										
Cargo Aircraft	<input checked="" type="checkbox"/>										
Airport of Destination: <b>STOCKHOLM</b>				Shipment type: <i>(delete non-applicable)</i> <input checked="" type="checkbox"/> Non-Radioactive <input checked="" type="checkbox"/> Radioactive							
Nature and Quantity of Dangerous Goods <i>(see sub-Section 8.1 of IATA Dangerous Goods Regulations)</i>											
Dangerous Goods Identification											
Proper Shipping Name	Class or Division	UN or ID No.	Packing Group	Subsidiary Risk	Quantity and type of packing	Packing Inst.	Authorization				
Infectious substance affecting humans (poliovirus)	6.2	UN 2814			1 x fibreboard box x 2g	602					
Dry Ice	9	UN 1845	III		5kg overpack used	904					
EXAMPLE											
<b>Additional Handling Information</b> INSERT EMERGENCY CONTACT NAME AND TELEPHONE NUMBER Prior arrangements as required by the IATA Dangerous Goods Regulations 1.3.3.1 have been made.											
<b>I hereby declare that the contents of this consignment are fully and accurately described above by the proper shipping name, and are classified, packaged, marked and labelled/placarded, and are in all respects in proper condition for transport according to applicable international and national governmental regulations.</b>  Two completed and signed copies of this Declaration must be handed to the operator						Name/Title of Signatory  Place and Date  Signature <i>(see warning above)</i>					
<b>Distribution:</b> One copy to accompany AWB One copy to be filed at airport of departure (with AWB-copy)											

Form 22902 VP-3.98



---

### 10.2.2 Biological products

Global Polio Network laboratories may occasionally ship cell lines or antisera which are categorized as biological products, but are not regulated when shipped because they are not considered to contain regulated infectious substances. In general, the shipping of biological products is only regulated if the material contains pathogens known to cause human or animal disease. In this case, the materials are classified as above (UN2814 or UN2900) and shipped according to the instructions given in the infectious substances section above.

### 10.2.3 Diagnostic specimens

Global Polio Network laboratories frequently ship materials categorized as diagnostic specimens. Specimens that are known, or reasonably expected, to contain pathogens in risk groups 2, 3, or 4 should be classified as Division 6.2 and shipped under UN2814 as an infectious substance and those packing instructions followed.

Specimens where a relatively low probability exists that pathogens of risk group 2 or 3 are present, are transported for the purpose of initial diagnosis for other than the presence of pathogens, or are transported for routine screening tests are NOT CONSIDERED INFECTIOUS SUBSTANCES and should be packed in the following manner. Hand carriage of such specimens on airlines is strictly prohibited by international carriers, as is the use of diplomatic pouches for that purpose. Original stool samples must be packaged in outside thread screw-cap containers of suitable size, for example 1.8 ml cryovials. After tightening the cap, sealing tape, for example Parafilm or water-proof plastic tape, must be applied over the cap and top of the tube. The sealed tube must be placed in a suitably sized plastic bag together with a small amount of absorbent material, for example cotton wool. The bag must be sealed, either using a heated bag sealer or waterproof adhesive tape. All specimens should be “double-bagged” in sealed plastic bags. Two or more sealed specimens from the same patient may be placed in a larger plastic bag and sealed. Specimens from different patients should never be sealed in the same bag (*see Figure 10.6*).

**Figure 10.6: Preparing specimens for shipment**

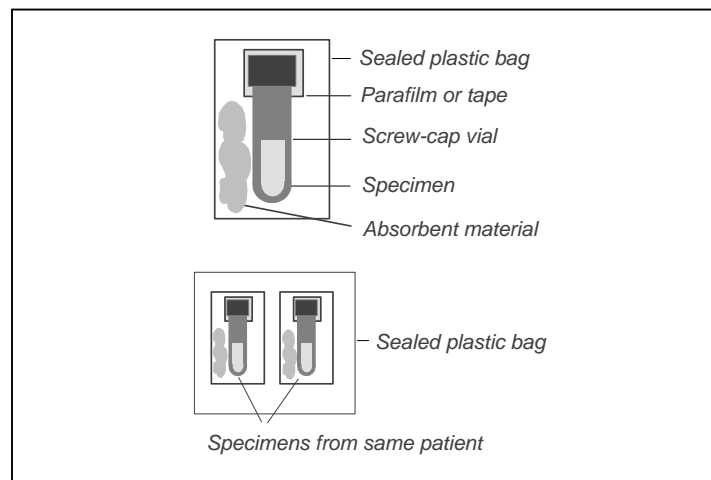

Sealed bags containing the specimens should be placed inside plastic containers with screw-cap lids. Provided the specimens have been double-bagged properly in sealed plastic bags, specimens from several patients may be packed inside the same plastic container. Additional absorbent material should be placed inside the container to absorb any leakage that may occur. The total number of specimens that can be packed inside a single container will depend on the size of the primary containers holding the specimen and the amount of additional packaging material (plastic bag and absorbent material) but should be between 6 to 10 individual specimens.

**Figure 10.7: Preparing multiple specimens for shipment**

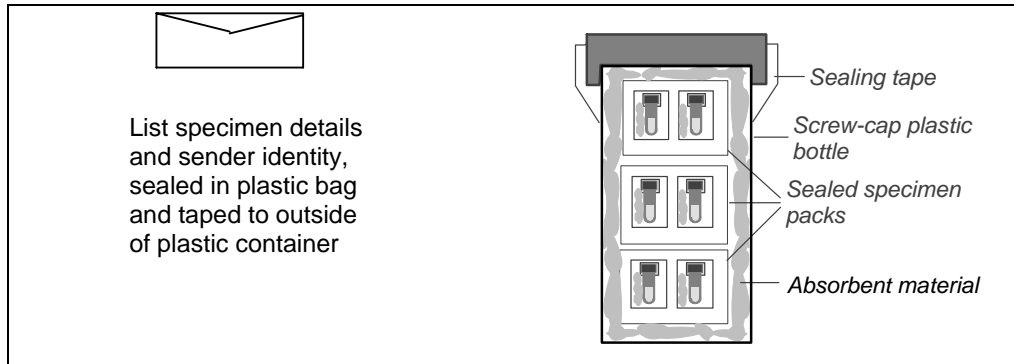

Written details of the specimens, any letters or additional information concerning the specimens, and details identifying the sender and the intended recipient, should be sealed in a plastic bag and taped to the outside of the plastic container (*see Figure 10.8*).

Sealed plastic containers should be fitted into insulated containers (polystyrene) with a fibreboard outer packaging. The insulated container and outer packaging must conform to *IATA Dangerous Goods Regulations Packaging Instruction 650*. This ensures that strict performance tests have been performed by the manufacturer on the package, which include a drop test as outlined by IATA. The package should contain frozen ice-packs, or additional plastic containers containing ice. Ice-packs should be leakproof and wrapped in an outer package to prevent their contents from spilling out in the case of unintended melting. If approved packaging is not available, EPI vaccine carriers can be allocated for this purpose only if the transportation is within national borders by road or rail. However, once used for specimen transport, they should never again contain vaccine. The materials and equipment used to cool polio specimens can become contaminated with the virus. Therefore these materials should be destroyed or disinfected after each use. EPI vaccine carriers do not conform to the IATA regulations and should not be used to ship materials nationally or internationally by air.

When the bag of specimens has been placed in the transport box, the maximum number of frozen ice-packs which can be fitted around the specimens should be inserted. If available, a cold chain monitor should be inserted. If dry ice is used to keep the specimens cool, then the package requires a *Declaration of Dangerous Goods Class 9, UN1845* and must comply with packing instruction 904. The

following instructions comply with those rules. These specimen carriers and ice-packs can be reused **ONLY** after thorough washing in water and/or hypochlorite solution.

The maximum volume that can be legally packed in a single package is **500 ml** on passenger aircraft and 4 litres if shipped on cargo aircraft. Since each stool specimen is usually approximately 1 to 2 ml, the 500 ml limit does not represent a problem.

The inside of the insulated container should be packed with additional materials to prevent the plastic container from moving around during transport.

The outside of the package should be marked as follows (*see Figure 10.8*):

- the sender's name, address and contact telephone / fax numbers;
- the receiver's name, address and contact telephone / fax numbers;
- marking indicating "Diagnostic Specimens – NOT RESTRICTED";
- marking indicating "Packed in compliance with IATA packing instruction 650";
- **if dry ice is used**, the package should indicate "UN 1845 Dry Ice", the weight of the dry ice included in the package when shipment was started, and a Sender's Declaration for Dangerous Goods must be attached (*see Figure 10.5*).

**Figure 10.8: Outer packaging and labels for shipment of diagnostic specimens**

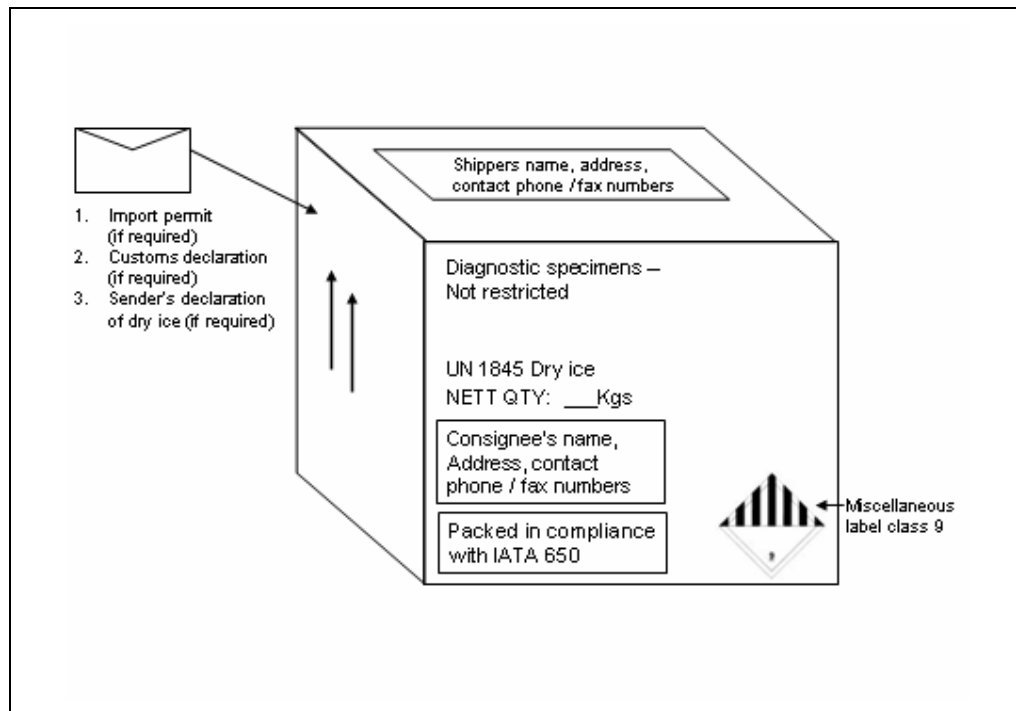

It may be of benefit to include an additional label with the following request: "Refrigerate package where possible".

---

The box should be sealed using wide sealing tape, taking care not to obscure the labels with the tape. If the outer packaging shown in Figure 10.8 is placed within another package (i.e. an “over pack”), then both outer packaging and “over pack” must bear all of the information shown in Figure 10.8. Additionally, the over pack must bear a statement indicating that “inner packages comply with prescribed specifications”.

Specimens packaged in this way do *not* require a *Declaration of Dangerous Goods*, as is required for the “infectious substances” category, but the airway bill must include the words: “*Diagnostic specimens packed in compliance with IATA packing instruction 650.*”

### 10.3 Genetically modified microorganisms and organisms

Global Polio Network laboratories may occasionally ship L20B cell lines or transgenic mice which are categorized as genetically modified microorganisms and organisms, but are not regulated when shipped because they are not considered to be regulated infectious substances. In general, the regulations state that any genetically modified microorganism which meets the definition of the “infectious substance” category should be shipped according to those regulations. Genetically modified microorganisms which do not meet the definition of infectious substances, but which are capable of altering animals, plants or microbiological substances in a way not normally the result of natural reproduction, should be packed using the triple packaging system and placed in a IATA approved container.

Genetically modified microorganisms and organisms not meeting the above criteria are not subject to international shipping regulations, but may be affected by national government regulations.

#### 10.3.1 Medical wastes

Global Polio Network laboratories do not normally ship materials categorized as medical wastes. In general, only medical wastes that can be categorized as “infectious substances”, as described by the regulations, are subject to those shipping regulations. All other medical wastes are deemed to have a relatively low probability that infectious substances are present. Decontaminated wastes, which previously contained infectious substances as defined by the regulations, are not considered dangerous unless the criteria of another category are met.

### 10.4 Preparing the documentation and sending the package

The documentation required to be completed for shipping materials is determined by the nature of the materials being sent. In general, each shipment should be accompanied with the following documents:

- 
- *Sender's Declaration of Dangerous Goods* (only those goods classified as infectious substances 6 or if using dry ice);
  - a packing list/proforma invoice/customs declaration/commercial invoice which includes the receiver's address, the number of packages, detail of contents, weight, value(required for international shipping only; *see Figure 10.9*);
  - airway bill if shipped by air;
  - export/import documentation, if required;
  - the airway bill marked with the following information:
    - name, address, telephone/telex of receiver
    - number of specimens
    - “highly perishable”
    - “telephone receiver upon arrival” (repeat telephone number)
    - handling information:  
**“URGENT: DO NOT DELAY:  
Biological specimens;  
Highly perishable;  
Store at 4°C to 8°C.”**

#### *10.4.1 Notification of the receiver*

Once the package has been sent, the receiver should be immediately notified of the following:

- number of specimens;
- estimated number of cartons and weight;
- flight and arrival date/time;
- airway bill number.

In addition, the receiver should be informed that a copy of the airway bill has been mailed to the receiving laboratory and be requested to inform the sender if the package is not received.

#### *10.4.2 Notification of the sender*

Once the package has been received, the receiver should immediately notify the sender of the receipt and condition of the shipment and any problems encountered. This can be facilitated by the sender including a “fax back” form in the shipment that the receiver can use for that purpose.

**Figure 10.9: Example of customs declaration**

1 May 2000	
<b>To whom it may concern:</b>	
This shipment contains INFECTIOUS biological samples packed in accordance with IATA packing instruction 602. These samples are to be used for medical research purposes only. These samples have no commercial value and are not for resale. For customs purposes only we place a nominal value of AU\$ 10.	
<b>Contents:</b>	
<ul style="list-style-type: none"><li>• full scientific name: enteroviruses</li><li>• volume per vial: 1ml</li><li>• number of vials: 5</li><li>• origin: human</li><li>• country of origin: The Netherlands.</li></ul>	
<b>From:</b>	Mr. Robert Pringle Victorian Infectious Diseases Reference Laboratory 10 Wreckyn Street North Melbourne, Vic. F3051 AUSTRALIA
<b>To:</b>	WHO Regional Office for the Western Pacific Attention: Regional Adviser EPI World Health Organization 1000 Manila PHILIPPINES
<b>Value:</b>	AU\$ 10.00
Robert Pringle Laboratory Manager VIDRL North Melbourne Victoria, Australia	

---

# 11. Data management

An essential part of the work of every laboratory is to record the details of all specimens tested, to record the results of testing, and to report the results. A good laboratory will also analyse the results it obtains, interpret the results, looking for epidemiological patterns or trends, and summarize results in the form of regular reports. The term “data management” covers all of these activities, and is an essential function of any disease surveillance system. Good laboratory data management is crucial to the polio eradication programme. Poor data management results in wasted time, effort and money, and makes it more difficult to reach our goal of eradicating wild polioviruses.

Good data management starts by understanding:

- the meaning of the information generated;
- what you need to tell to people outside of the laboratory;
- who you need to tell it to;
- how often you need to tell it.

Every laboratory needs to:

- report the results, in an organized format, to the polio eradication programme and back to the person who submitted the specimens;
- produce reports of its work to the director or head of the institute as annual reports or progress reports;
- produce summary reports to justify why it should continue to receive more funding.

Once all these requirements have been identified, thought can be given to what information must be recorded so that the requirements can most easily be met. WHO has established a set of minimum information (core variables) to be recorded on each specimen from an AFP or suspected polio case. These are described in this Section. As a general rule, the more information that has to be collected and recorded, the greater the chance that the information will be of lower quality, with more omissions and mistakes. It is always easier to collect and accurately record less information than more information, — but if less information is collected it is essential that it is the **required** information.

---

The next step in data management is to decide how the information is to be physically recorded and stored. All laboratories maintain specimen registers and laboratory results books. These are often in the form of paper records, written line by line, with information entered into specific columns. Such records are called line-listings, since all the information relating to that specimen or case can be found by reading along the line of information.

For laboratories with a small workload, paper records are enough to fulfil all the reporting requirements. For laboratories with larger workloads it is often more convenient to establish a computer record system. In accordance with Regional network requirements, a simple spreadsheet system (using software such as Excel), reflecting the line-listing of paper records, may be sufficient for some laboratories. Although useful for some types of analysis, computer spreadsheets are not very easy to manipulate when using large amounts of information. For large amounts of information it is better to establish a computer database (using software such as EpiInfo, FoxPro or Access).

The choice of exactly how to computerize laboratory record keeping depends on a number of factors, including:

- user preference;
- hardware availability and capacity;
- software availability and cost;
- type of programming required to use the software;
- local expertise to develop and maintain the system.

At a minimum, the system chosen should allow rapid and accurate access to chosen or selected records, be able to perform simple calculations, such as frequencies and time intervals, and be able to create tables and graphs. It is often an advantage to establish a “menu system” to help non-advanced users and to make repetitive actions, such as data entry, more efficient. The system must also be well documented for both users and programmers. The documentation should include clear descriptions of installation procedures, operation, structure, adaptation to specific needs, required maintenance activities, file management requirements, and coding lists if coded information is used.

Any computerized laboratory records system should contain the following components:

- data entry;
- data cleaning (programmes that detect errors in the information entered);
- routine backup of data;
- routine analysis and reporting (for decision-making, action, monitoring);
- feedback (information to be sent back to the case investigators);
- feedforward (information to be reported to the next level).

In designing any laboratory results recording system, it is essential to involve someone who understands the disease control objectives, strategies, surveillance



---

needs and performance indicators of the activity. This will normally be someone from a more central level. The feedforward component in particular cannot be designed unless the next level has clearly specified its information requirements and the reporting format and structure most suited to its needs.

What information is reported, where it is reported from and where it is reported to, must be clearly agreed upon by all parties involved in the system. Feedback and feedforward reports will obviously have different formats, and different frequencies. Ideally, all information flow should be hierarchical, going from one level to the next, without missing levels. Information can also be “broadcast” (sent to several sources, at different levels, at the same time). Whatever the method of reporting, a diagram should be made of information flow, including the frequency of reporting, and distribution to all parties so that everyone involved understands the reporting system. Figure 11.1 shows the classic flow of specimens and information for the polio eradication initiative. Once a pattern of information flow is established it is very important that it be followed without exception. It is also important to review the system from time to time to make sure that it is doing the job it was designed to do and to decide if improvements can be made. If any changes are made to the system it is essential that all parties involved are informed of the changes and agree to them.

Maintaining laboratory records and keeping them accurate and relevant involve following good management practices and a clear designation of responsibilities. The success or failure of any public health or disease control initiative depends on establishing and maintaining a good information exchange system, with accurate and timely data being provided for appropriate action. The importance of good laboratory data management cannot be overstated.

### **11.1 Recording receipt of specimens**

The following minimum information should be included on the laboratory request form accompanying the specimen:

- EPIID Number (in an agreed format);
- patient name;
- province (or region) of report;
- town/district of report;
- province (or region) of residence of the case;
- town/district of residence of the case;
- country code;
- whether the case has been immunized;
- date of last OPV;
- AFP or contact;
- if a contact, EPIID number of the related case;
- specimen type (stool, etc.);
- date of onset of paralysis (exact date, the month is minimum requirement);
- date of first specimen collection;
- date of second specimen collection.

The following additional information should be recorded by the laboratory on receipt of a specimen:

- date specimen received in laboratory;
- specimen arrived frozen or with ice present (for feedback to EPI) (y/n);
- specimen arrived in amount large enough for full laboratory analysis (y/n);
- specimen arrived with no evidence of leakage or desiccation (y/n).

**Figure 11.1: Polio laboratory data flow:  
Laboratory results and performance monitoring data flow**

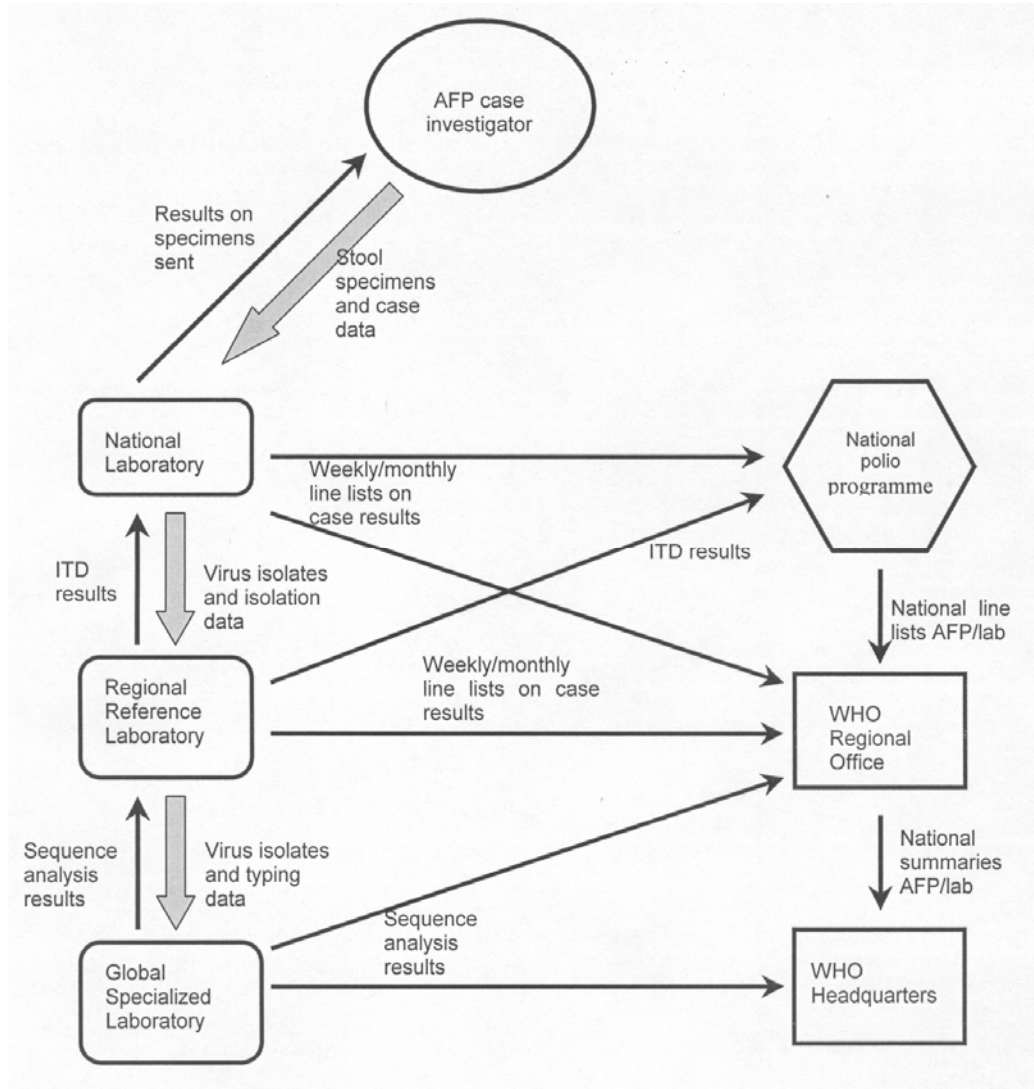

**Figure 11.2: Polio laboratory data flow:  
laboratory data feedback**

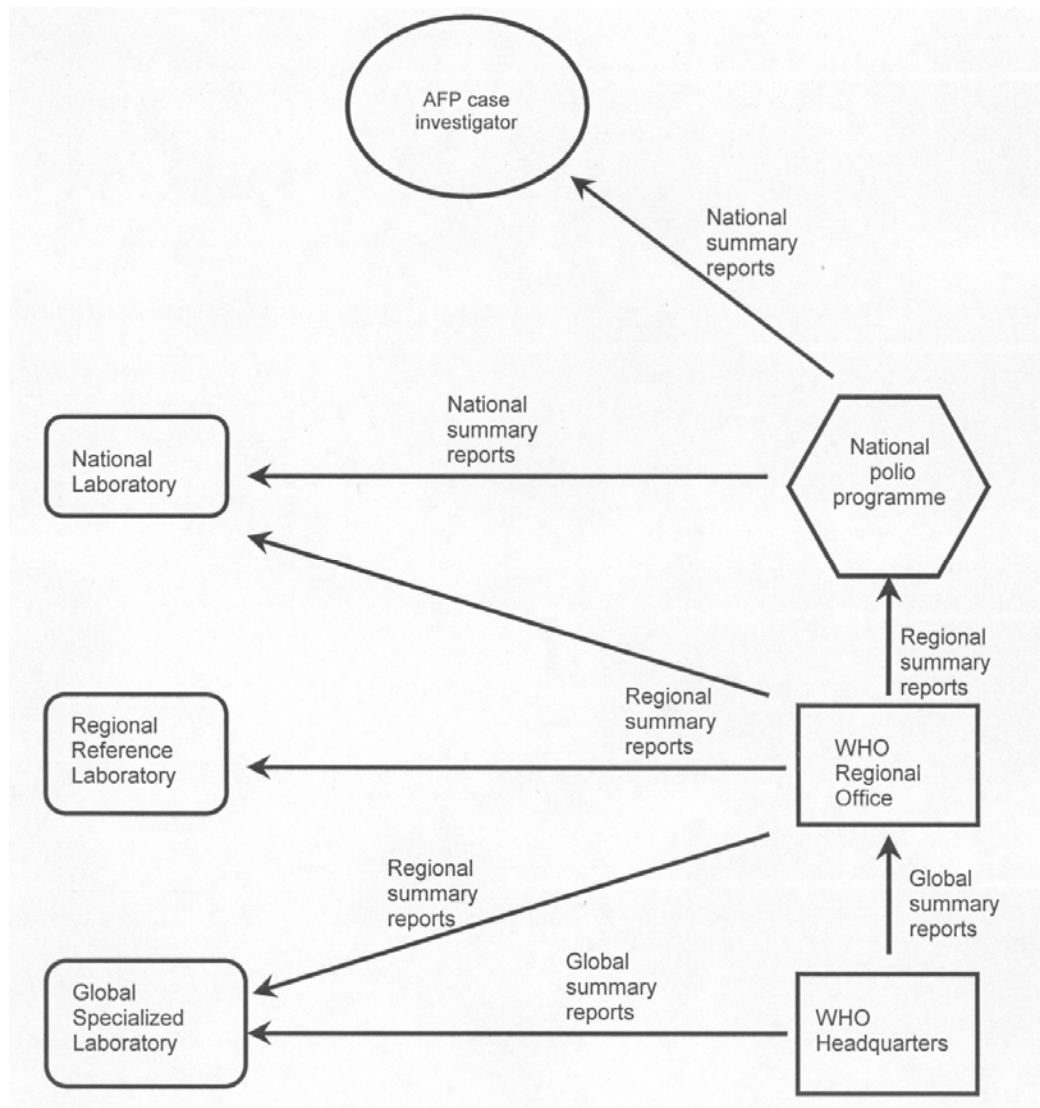

---

## 11.2 Recording laboratory results

### 11.2.1 *Virus isolation and characterization*

Stool specimens should be processed as soon as possible after arrival in the laboratory. It is assumed that chloroform extraction will have been performed on all specimens within one working day of arrival in the laboratory, and that stool extracts will be available for inoculation onto cell culture. It is not possible however to have cell monolayers ready for inoculation at all times. Therefore, for laboratory management purposes and eventually for certification documentation, it is important to record the date when the first cell monolayers are inoculated. It is also important to record when CPE is first observed in a culture. Standard WHO recommendations require two consecutive passes totalling 14 days of incubation in each cell line used. Isolates obtained from specimens that are negative in L20B cells but positive in RD cells should be repassaged in L20B cells to exclude the possibility that they are polioviruses. Information relating to each of these passes should be recorded separately.

In the past this information was recorded only in laboratory workbooks, but summaries may be required to document laboratory activities for certification. It is now recommended to record this information in a standard database, rather than trying to collect and analyse the information retrospectively. Experience has shown that the easiest way to record information on isolation results is to establish a **specimen-based** database, with each line of information relating to one specimen. Thus, for a case with two specimens collected and processed there will be two lines of information.

The recommended minimum information to be collected and recorded on specimen processing and isolation results should include the following:

- whether the specimen was processed (y/n);
- date of specimen extraction;
- temperature at which extract stored;
- date of first inoculation onto L20B cells;
- result of first inoculation into L20B cells;
- date of first inoculation onto RD cells;
- result of first inoculation into RD cells
- date of second inoculation onto L20B cells;
- result of second inoculation into L20B cells and date of result;
- date of second inoculation onto RD cells;
- result of second inoculation into RD cells and date of result;
- date of inoculation of L20B-negative, RD-positive isolate into L20B;
- result for L20B passage and date of result;
- date final isolation result available.

---

For standard purposes the date of harvesting of cultures and the date of neutralization assays would be recorded only in laboratory workbooks. However, it is possible that in some instances National Certification Committees will require information of this type from the laboratories. Again, it is a good idea to record this information in a standard database immediately rather than trying to collect and analyse the information retrospectively. Experience gained over the years has shown that the easiest way to record information on typing results is to establish an **isolate-based** database, with each line of information relating to a viral isolation resulting in CPE. Thus, if a single AFP case has two specimens collected and each specimen is inoculated onto two cell lines, and a virus isolate is obtained in each inoculated cell line, there will be four lines of information in the isolate database relating to the AFP cases. Information on the isolates can be linked to information on the specimen through the specimen Id number and the EPIId number.

The recommended information to be collected and recorded on typing of virus isolates should include the following:

- EPIId number of case;
- laboratory specimen number;
- isolate ID number (a number based on the specimen laboratory number is recommended);
- date of typing;
- typing plate identification;
- typing result: if polio present, the type(s);
  - if NPEV present, whether it was typed or not;
  - if typing needs to be repeated;
- date final typing results available;
- date results sent to National EPI manager;
- date sent to WHO Regional Office;
- date virus isolate sent to Regional Reference Laboratory;
- date ITD results received from Regional Reference Laboratory.

### *11.2.2 Intratypic differentiation*

All poliovirus isolates should be characterized by intratypic differentiation as soon as possible after isolation. Recording information on intratypic differentiation is now complicated because several National Polio Laboratories are capable of carrying out one or more intratypic differentiation tests. The current recommendation is that all poliovirus isolates originating from cases of AFP, or from suspected outbreaks of poliomyelitis, must be confirmed and characterized by intratypic differentiation in a laboratory accredited by WHO to carry out such differentiation. Poliovirus isolates originating from routine clinical virological investigations, epidemiological surveys and environmental studies where wild poliovirus is not expected to occur may be characterized by accredited National Laboratories capable of carrying out intratypic differentiation. Acceptance of the results of these laboratories is at the discretion of the WHO Regional Offices and the Regional Polio Certification Committees.

---

The minimum recommended information to be sent with the material for intratypic differentiation includes the following:

- case identification number (EPIId);
- laboratory specimen number;
- isolate identification number;
- passage history of isolate (e.g. L20B second pass);
- date of sending isolate to RRL.

The minimum recommended information to be recorded by the laboratory carrying out intratypic differentiation includes the following:

- date referred material received;
- EPIId number;
- ITD laboratory sample number;
- referring laboratory sample number;
- referring laboratory isolate number;
- material type;
  
- date of ITD processing by method 1;
- result: polio 1 present (non-Sabin or Sabin-like);
- result: polio 2 present (non-Sabin or Sabin-like);
- result: polio 3 present (non-Sabin or Sabin-like);
- result: NPEV present;
- result: no virus present;
- result: not interpretable;
  
- date of ITD processing by method 2;
- result: polio 1 present (non-sabin or sabin-like);
- result: polio 2 present (non-sabin or sabin-like);
- result: polio 3 present (non-sabin or sabin-like);
- result: NPEV present;
- result: no virus present;
- result: not interpretable;
  
- date final ITD result available;
- date result sent to National EPI programme;
- date result sent to national laboratory;
- date result sent to WHO regional office;

- 
- if virus isolates were sent for genomic sequencing:
    - date isolates sent;
    - sequencing results;
    - date sequencing results received.

### **11.3 Reporting laboratory activity and results**

Laboratory results must be reported in a timely and accurate manner for several reasons. Reporting of laboratory results has a direct effect on the poliomyelitis eradication programme through:

- feedback to national EPI teams for case follow-up and planning supplementary immunization activities;
- coordination of the eradication programme through WHO and other international agencies and bodies;
- monitoring of laboratory results and performance to identify possible problems and constraints.

#### ***11.3.1 Feedback to EPI teams***

Details of how and when laboratories report to EPI managers should be arranged locally. In general, however, results should be made available on individual cases as they become available, either directly to the case investigators or through the EPI managers. Summaries of results available (including pending results) should be sent to the EPI managers on a regular basis, either weekly or monthly depending on local requirements. Laboratories should also be able to respond to requests for information on the status of investigations on specimens from individual cases. There are three levels of detail that reports can take:

- a) Isolation result after two consecutive passages totalling 14 days in the two recommended cell lines. Approximately 75 to 80 % of all specimens from AFP cases can be expected to be negative for virus isolation and reported as such. This should be done within 28 days of receipt of the specimens. Local arrangements may require a laboratory to report positive CPE pending typing results, but this should be decided in consultation with the EPI managers.
- b) Typing result on specimens with positive CPE in at least 1 cell line. This can usually be done within 28 days of specimen receipt, but may take a few additional days for difficult isolates.
- c) Intratypic differentiation results reported from the Regional Reference Laboratory. These should be available within 14 days of receipt of the isolates in the reference laboratory.

Wild-type poliovirus positives should be reported within 24 hours and, in countries or regions that have been free of wild poliovirus for some time, they should be treated as an emergency.

---

Details of inadequate specimens and inadequate transport of specimens should be reported to EPI managers as soon as possible so that field staff can be informed and improvements made.

### *11.3.2 Weekly/monthly reports to WHO*

All national laboratories are requested to provide a weekly or monthly report of results to WHO, the frequency depending upon the WHO Region requirements. This information is used to update country summaries, monitor laboratory performance and coordinate international agency activity. Data provided in these reports are essential to the coordination of the programme as a whole, and it must be a priority activity of all laboratories in the network to send routine reports in a timely and accurate manner. In the WHO regional office the laboratory reports from each country are analysed and the results summarized in table format.

Because of the amount of data involved and the time required to analyse the information, it is now essential that laboratories handling more than 100 stool specimens a year provide their routine reports in computer database format, on computer diskettes or sent by e-mail. WHO can now provide a set of laboratory data management programs suitable for most of the polio laboratories in the global laboratory network.

### *11.3.3 In-house reporting*

All laboratories are required to prepare reports on laboratory activities and results to the head of their institution, management committees or governments. These reports may be monthly, quarterly or annual. Different laboratories will be required to report in different ways, but it is intended that the basic laboratory report format, recommended by WHO, should provide the foundation of these in-house reports. If the WHO routine reporting database is maintained in an accurate and up-to-date condition it should be easy for laboratory staff to analyse their polio data and to prepare in-house reports.

## **11.4 Laboratory data for certification**

Certification committees and commissions will be looking for evidence to **prove** that the polio laboratory services could isolate and identify wild poliovirus from a stool specimen of a child with poliomyelitis if there were such a case. Reporting of results will have a direct effect on certification of polio-free status by providing a continuous record demonstrating that:

- wild poliovirus has been absent from the country or region for at least three years;
- a fully integrated surveillance system exists;
- recommended and acceptable procedures have been followed;
- laboratory performance has been at an acceptable level;
- laboratory accuracy has been at an acceptable level;



- 
- the laboratory is complying with requirements for containment of wild poliovirus stocks.

Detailed documentation on standard laboratory performance indicators for each year that the laboratory has served as the national polio laboratory will be required for submission to the National Certification Committees. The following **minimum** documentation will be required from each national laboratory for as many years as possible, but at least for the three years immediately prior to certification:

#### *11.4.1 Laboratory process and results*

##### *AFP cases*

- The total number of stool specimens received, the total number of AFP cases from which stool specimens were received and the total number of stool specimens that were processed each year.
- The total number of non-polio enteroviruses that were isolated and the non polio enterovirus isolation rate.
- The total number of polioviruses that were isolated, the total number of isolates that were sent for intratypic differentiation, and the total number of AFP cases that had results sent for intratypic differentiation.
- The results of all intratypic differentiation studies, by specimen and AFP case.

##### *Non-AFP specimens*

- The total number of stool specimens received from non-AFP cases, including healthy child surveys and special studies, together with specimens from environmental surveys, that were submitted for enterovirus studies and processed each year.
- The total number of non-polio enteroviruses that were isolated and the non polio enterovirus isolation rate.
- The total number of polioviruses that were isolated, the total number of isolates that were sent for intratypic differentiation, and the total number of specimens that had results sent for intratypic differentiation.
- The results of all intratypic differentiation studies, by specimen and specimen type.

##### *Missing laboratory data*

- The reasons for each instance in which a specimen that was received in the laboratory was not processed.
- The reasons for each failure to send a poliovirus isolate for intratypic differentiation.
- The reasons for each missing intratypic differentiation result.

Detailed laboratory information will be required for certification; the sooner a system is set in place for recording and maintaining this information the easier it will be to provide it when requested.

---

# Bibliography

- Alexander JP, Jr., Gary HE, Jr., Pallansch MA. Duration of Poliovirus Excretion and Its Implications for Acute Flaccid Paralysis Surveillance: a Review of the Literature. *The Journal of Infectious Diseases*, 1997,175 Suppl 1:S176-S182.
- Balanant J et al. The Natural Genomic Variability of Poliovirus Analyzed by a Restriction Fragment Length Polymorphism Assay. *Virology*, 1991, 184:645–54.
- Bellmunt A et al. Evolution of Poliovirus Type I During 5.5 Years of Prolonged Enteral Replication in an Immunodeficient Patient. *Virology*, 1999, 265:178–84.
- Blomqvist S et al. Characterization of a recombinant type 3/type 2 poliovirus isolated from a healthy vaccinee and containing a chimeric capsid protien VP1. *The Journal of General Virology*, 2003, 84: 573–580.
- Buttinelli G et al. Nucleotide variation in Sabin type 2 poliovirus from an immunodeficient patient with poliomyelitis. *The Journal of General Virology*, 2003, 84:1215–1221.
- Cammack N et al. Intertypic Genomic Rearrangements of Poliovirus Strains in Vaccinees. *Virology*, 1988, 167:507–14.
- Centers for Disease Control and Prevention. Acute Flaccid Paralysis Associated With Circulating Vaccine-Derived Poliovirus – Philippines, *Morbidity and Mortality Weekly Report*, 2001, 50:874–5.
- Centers for Disease Control and Prevention. Certification of Poliomyelitis Eradication – the Americas. *Morbidity and Mortality Weekly Report*,1994, 43:720-2.
- Centers for Disease Control and Prevention. Certification of Poliomyelitis Eradication – Western Pacific Region. *Morbidity and Mortality Weekly Report*, 2001, 50:1–3.
- Centers for Disease Control and Prevention. Certification of Poliomyelitis Eradication – European Region. *Morbidity and Mortality Weekly Report*, 2002, 51:572–4.
- Centers for Disease Control and Prevention. Global Progress Toward Laboratory Containment of Wild Polioviruses. *Morbidity and Mortality Weekly Report*, 2002, 51:993–6.

---

Centers for Disease Control and Prevention. Progress Toward Poliomyelitis Eradication – Egypt. *Morbidity and Mortality Weekly Report*, 2002, 51:305–7.

Centers for Disease Control and Prevention. Public Health Dispatch: Poliomyelitis – Madagascar. *Morbidity and Mortality Weekly Report*, 2002, 51:622.

De L et al. Genotype-Specific RNA Probes for Direct Identification of Wild Polioviruses by Blot Hybridization. *Journal of Clinical Microbiology*, 1997, 35:2834–40.

Dowdle WR et al. Can Post-Eradication Laboratory Containment of Wild Polioviruses Be Achieved? *Bulletin of the World Health Organization* 2002, 80:311–6.

Enders J, Weller T, Robbins FC. Cultivation of the Lansing Strain of Poliomyelitis Virus in Cultures of Various Embryonic Tissues. *Science* 1949, 109:85–7.

Expanded Programme on Immunization. Global eradication of poliomyelitis by the year 2000. *Weekly Epidemiological Record*, 1988, 63:161–162.

Expanded Programme on Immunization. *Field guide for supplemental activities aimed at achieving polio eradication*. WHO/EPI/GEN 95.1.

Gavrilin GV et al. Evolution of Circulating Wild Poliovirus and of Vaccine-Derived Poliovirus in an Immunodeficient Patient: a unifying model. *Journal of Virology*, 2000, 74:7381–90.

Georgescu MM, Delpeyroux F, Crainic R. Tripartite Genome Organization of a Natural Type 2 Vaccine/Nonvaccine Recombinant Poliovirus. *The Journal of General Virology*, 1995, 76 (Pt 9):2343–8.

Georgescu MM et al. High Diversity of Poliovirus Strains Isolated From the Central Nervous System From Patients With Vaccine-Associated Paralytic Poliomyelitis. *Journal of Virology*, 1994, 68:8089–101.

Hovi T, Stenvik M. Selective Isolation of Poliovirus in Recombinant Murine Cell Line Expressing the Human Poliovirus Receptor Gene. *Journal of Clinical Microbiology*, 1994, 32:1366–8.

International Air transport Association. *Infectious substances and diagnostic specimens shipping guidelines*. 4th Edition, 2003.

Kapsenberg JG, Ras A, Korte J. Improvement of enterovirus neutralization by treatment with sodium deoxycholate or chloroform. *Intervirology*, 1979, 12:329–334.

Khetsuriani N et al. Persistence of vaccine-derived polioviruses among immunodeficient persons with vaccine-associated paralytic poliomyelitis. *The Journal of Infectious Diseases*, 2003, 188(12):1845–52.

---

Kawamura N et al. Determinants in the 5' Noncoding Region of Poliovirus Sabin 1 RNA That Influence the Attenuation Phenotype. *Journal of Virology*, 1989, 63:1302–9.

Kew O et al. Outbreak of Poliomyelitis in Hispaniola Associated With Circulating Type 1 Vaccine-Derived Poliovirus. *Science*, 2002, 296(5566):356–9.

Kew O et al. Molecular Epidemiology of Polioviruses. *Seminars in Virology* 1995, 6:401–14.

Kew O, Pallansch M. The Mechanism of Poliovirus Eradication. In *Molecular Biology of Picornaviruses*, Semler BL, Wimmer E, eds. ASM Press: Washington, 2002, 481–91.

Kew OM et al. Prolonged Replication of a Type 1 Vaccine-Derived Poliovirus in an Immunodeficient Patient. *Journal of Clinical Microbiology*, 1998, 36:2893–9.

Kilpatrick DR et al. Serotype-Specific Identification of Polioviruses by PCR Using Primers Containing Mixed-Base or Deoxyinosine Residues at Positions of Codon Degeneracy. *Journal of Clinical Microbiology*, 1998, 36:352–7.

Kilpatrick DR et al. Group-Specific Identification of Polioviruses by PCR Using Primers Containing Mixed-Base or Deoxyinosine Residue at Positions of Codon Degeneracy. *Journal of Clinical Microbiology*, 1996, 34:2990–6.

Kinnunen L et al. Rapid Molecular Evolution of Wild Type 3 Poliovirus During Infection in Individual Hosts. *The Journal of General Virology*, 1990, 71 (Pt 2):317–24.

Lipskaya GY et al. Frequent Isolation of Intertypic Poliovirus Recombinants With Serotype 2 Specificity From Vaccine-Associated Polio Cases. *Journal of Medical Virology*, 1991, 35:290–6.

Liu HM et al. Molecular Evolution of a Type 1 Wild-Vaccine Poliovirus Recombinant During Widespread Circulation in China. *Journal of Virology*, 2000, 74:11153–61.

Martin J et al. Evolution of the Sabin Strain of Type 3 Poliovirus in an Immunodeficient Patient During the Entire 637-Day Period of Virus Excretion. *Journal of Virology*, 2000, 74:3001–10.

Martin J et al. Isolation of an intertypic poliovirus capsid recombinant from a child with vaccine-associated paralytic poliomyelitis. *Journal of Virology*, 2002, 76:10921–8.

Minor PD, Dunn G. The Effect of Sequences in the 5' Non-Coding Region on the Replication of Polioviruses in the Human Gut. *The Journal of General Virology*, 1988, 69 (Pt 5):1091–6.

---

Nadkarni SS, Deshpande JM. Recombinant murine L20B cell line supports multiplication of group A Coxsackieviruses. *Journal of Medical Virology*, 2003, 70(1):81–5.

Nathanson N, Martin JR. The Epidemiology of Poliomyelitis: Enigmas Surrounding Its Appearance, Epidemicity, and Disappearance. *American Journal of Epidemiology*, 1979, 110:672–92.

Pallansch M, Roos R. Enteroviruses: polioviruses, coxsackieviruses, echoviruses, and newer enteroviruses. In *Field's Virology*, fourth edition, Knipe D, Howley P, Griffin D, Lamb GA, Martin M, Roizman B, Straus S, eds. Lippincott Williams and Wilkins: Philadelphia, 2001; 723–75.

Pipkin PA et al. Characterisation of L Cells Expressing the Human Poliovirus Receptor for the Specific Detection of Polioviruses in Vitro. *Journal of Virological Methods*, 1993, 41:333–40.

Plotkin SA, Murdin A, Vidor E. Inactivated Polio Vaccine. In *Vaccines*, Third Edition edition, Plotkin SA, Orenstein WA, eds. W.B. Saunders: Philadelphia, 1999, 354–63.

Ren RB et al. Transgenic Mice Expressing a Human Poliovirus Receptor: a New Model for Poliomyelitis. *Cell*, 1990, 63:353–62.

Rousset D et al. Recombinant vaccine-derived poliovirus in Madagascar. *Emerging Infectious Diseases*, 2003, 9:885–887.

Sabin AB et al. Live, Orally Given Poliovirus Vaccine. Effects of Rapid Mass Immunization on Population Under Conditions of Massive Enteric Infection With Other Viruses, 1960. *Bulletin of the World Health Organization*, 1999, 77:196–201.

Sutter R, Cochi S, Melnick JL. Live attenuated poliovirus vaccine. In *Vaccines*, Third Edition edition, Plotkin SA, Orenstein WA, eds. W.B. Saunders: Philadelphia, 1999; 364–408.

Technical Consultative group on Global Eradication of Poliomyelitis. Endgame Issues for the Global Polio Eradication Initiative. *Clinical Infectious Diseases*, 2002, 34:72–7.

Van der Avoort HG et al. Comparative Study of Five Methods for Intratypic Differentiation of Polioviruses. *Journal of Clinical Microbiology*, 1995, 33:2562–6.

Acute flaccid paralysis associated with circulating vaccine-derived poliovirus, Philippines, 2001. *Weekly Epidemiological Record*, 2001, 41:319–320.

Wimmer E, Hellen CU, Cao X. Genetics of Poliovirus. *Annual Review of Genetics*, 1993, 27:353–436.

---

Wood D, Sutter R, Dowdle W. Stopping Poliovirus Vaccination After Eradication: Issues and Challenges. *Bulletin of the World Health Organization*, 2000, 78:347–63.

World Health Assembly. *Global eradication of poliomyelitis by the year 2000: resolution of the 41st World Health Assembly*. Resolution WHA 41.28. 1988. Geneva, Switzerland, World Health Organization.

World Health Organization. Expanding Contributions of the Global Laboratory Network for Poliomyelitis Eradication, 2000–2001. *Weekly Epidemiological Record*, 2002, 77:133.

World Health Organization. Progress Towards the Global Eradication of Poliomyelitis. *Weekly Epidemiological Record*. 2002,77:98–107.

World Health Organization. Transmission of Wild Poliovirus Type 2 – Apparent Global Interruption. *Weekly Epidemiological Record*, 2001, 76:95–7.

World Health Organization. *Manual for the virologic investigation of poliomyelitis* WHO/EPI/GEN/02.1. 2002. Geneva, Switzerland.

World Health Organization. *WHO global action plan for laboratory containment of wild polioviruses*. Geneva: World Health Organization; 1999. Report No.: WHO/V&B/99.32.

World Health Organization. *Guidelines for the safe transport of infectious substances and diagnostic specimens*. WHO/WMC/97.3.

Yang CF et al. Detection and Identification of Vaccine-Related Polioviruses by the Polymerase Chain Reaction. *Virus Research*, 1991, 20 :159–79.

Yang C-F et al. Circulation of endemic type 2 vaccine-derived poliovirus in Egypt from 1983 to 1993. *Journal of Virology*, 2003, 77:8366–8377.